

**YUW 750 XT  
4 Side Captured - Window Wall**

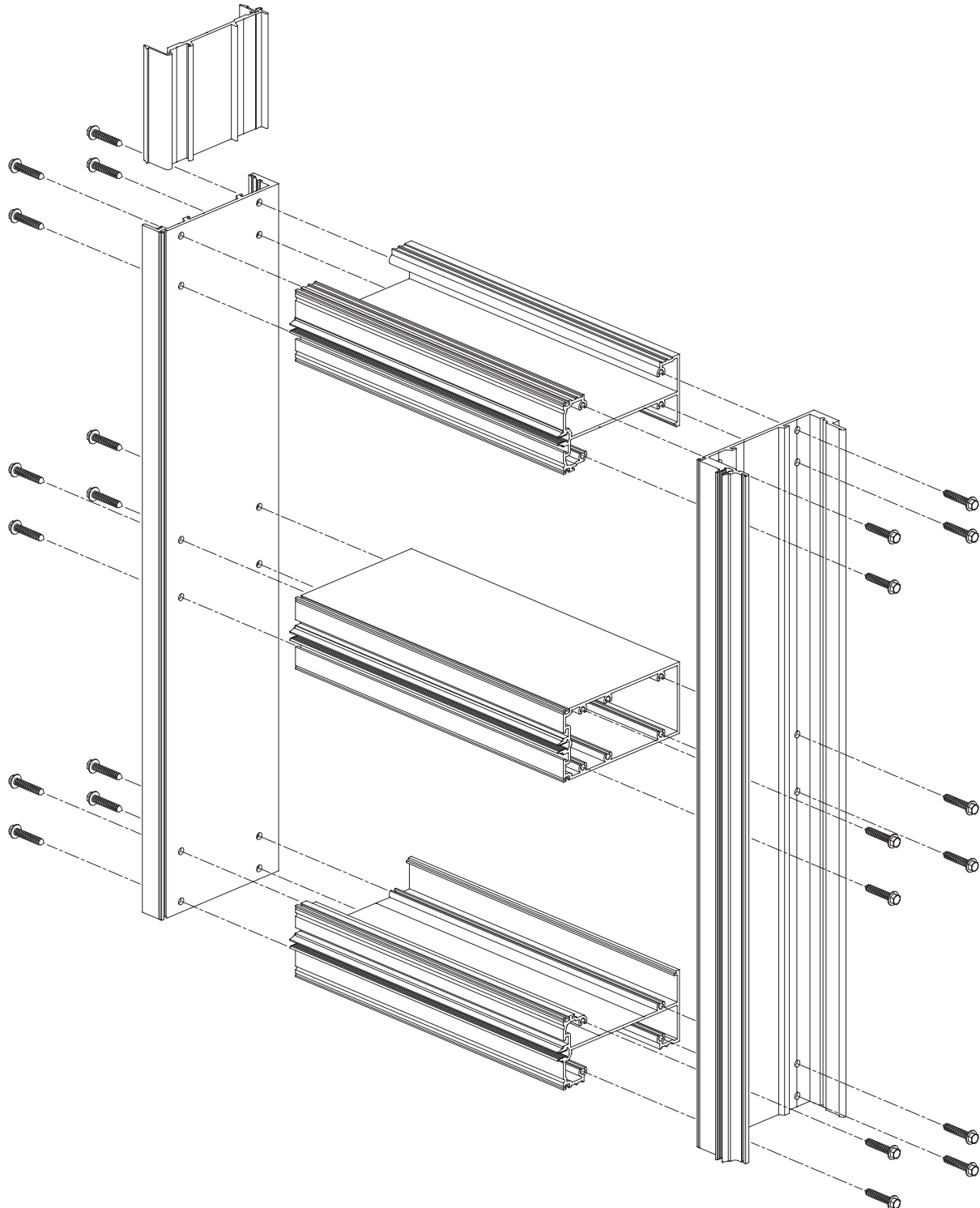

**Installation Manual**





**TABLE OF CONTENTS**

Installation Notes ..... Page ii

**PARTS DESCRIPTION**

YUW 750 XT Framing Members ..... Page 1 & 2

YUW 750 XT Accessories ..... Page 2 & 3

**INSTALLATION**

Unit Installation ..... Page 5

Pre-installation Sealant Note ..... Page 6

Unit Anchoring Method ..... Page 7

Apply Perimeter Sealant ..... Page 8











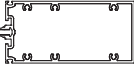



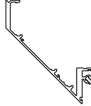
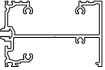
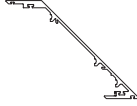

Install Flat Fillers ..... Page 8

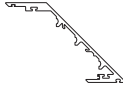
## Installation Notes

1. Do not drop, roll or drag boxes of aluminum framing. Move and stack boxes with proper support to prevent distortion. If fork lifts are used, be especially careful about striking the boxes when lifting or moving.
2. Store in a dry, out of the way area. If rain exposure, condensation or any water contact is likely, then all packaging material should be removed. Wet packaging materials will discolor and may stain aluminum finishes and paints.
3. All materials should be checked for quality and quantity upon receipt, YKK AP must be notified immediately of any discrepancies in shipment. Check to make sure that you have the required shims, sealants, supplies and tools necessary for the installation.
4. Carefully check the openings and surrounding conditions that will receive your material. Remember, if the construction is not per the construction documents, it is your responsibility to notify the general contractor in writing. Any discrepancies must be brought to the general contractor's attention before you proceed with the installation.
5. Gather your shop drawings, materials, packing list, and this installation manual. Carefully review parts location, the sequence it goes therein, when you glaze it and how you seal it. Installation instructions are of a general nature and may not cover every condition you will encounter. The shop drawings and/or installation manuals were prepared specifically for the product.
6. Any material substitutions must be of equal or greater quality.
7. Make certain that material samples have been sent for compatibility testing for all manufacturer's sealants involved. Make certain sealants have been installed in strict accordance with the manufacturer's recommendations and specifications.
8. Remember to isolate, in an approved manner, all aluminum from uncured masonry or other incompatible materials.
9. System-to-structure fasteners are not supplied by YKK AP. Fasteners called out on shop drawings are to indicate minimum sizes for design loading.
10. If any questions arise concerning YKK AP products or their installation, contact YKK AP for clarification before proceeding.
11. YKK AP storefront and/or curtain wall framing is typically completed before drywall, flooring and other products which may still be in process. Take the extra time to wrap and protect the work produced.
12. Cutting tolerances are plus zero, minus one thirty second unless otherwise noted.
13. Check our website, [www.ykkap.com](http://www.ykkap.com), for the latest installation manual update prior to commencing work.



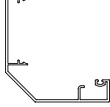
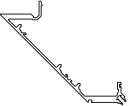
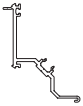
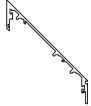
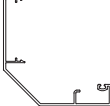

4 Side Captured

FRAMING MEMBERS















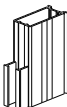
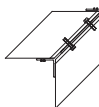

	<b>Intermediate Horizontal</b> For 7-1/2" System	<b>E9-7097</b>		<b>Outside Corner Male Mullion</b> For 6" System	<b>E9-7068</b>
	<b>Intermediate Horizontal</b> For 6" System	<b>E9-7064</b>		<b>Outside Corner Female Mullion</b> For 6" System	<b>E9-7069</b>
	<b>Open Back Head/Sill</b> For 7-1/2" System	<b>E9-7099</b>		<b>* Inside Corner Male Mullion</b> For 7-1/2" System	<b>E9-7047</b>
	<b>Open Back Head/Sill</b> For 6" System	<b>E9-7065</b>		<b>* Inside Corner Female Mullion</b> For 7-1/2" System	<b>E9-7048</b>
	<b>Male Mullion Half</b> For 7-1/2" System	<b>E9-7095</b>		<b>* Inside Corner Male Mullion</b> For 6" System	<b>E9-7070</b>
	<b>Male Mullion Half</b> For 6" System	<b>E9-7061</b>		<b>* Inside Corner Female Mullion</b> For 6" System	<b>E9-7071</b>
	<b>Female Mullion Half</b> For 7-1/2" System	<b>E9-7002</b>		<b>Pressure Plate</b> For 1-5/16" Glazing	<b>AS-7057</b>
	<b>Female Mullion Half</b> For 6" System	<b>E9-7062</b>		<b>Face Cover</b>	<b>E9-1206</b>
	<b>Jamb Mullion</b> For 7-1/2" System	<b>E9-7098</b>		<b>Outside Corner Pressure Plate</b> For 1" Glazing	<b>AS-7055</b>
	<b>Jamb Mullion</b> For 6" System	<b>E9-7063</b>		<b>Outside Corner Face Cover</b> For 1" Glazing	<b>E9-7056</b>
	<b>Outside Corner Male Mullion</b> For 7-1/2" System	<b>E9-7045</b>		<b>Outside Corner Pressure Plate</b> For 1-5/16" Glazing	<b>AS-7081</b>
	<b>Outside Corner Female Mullion</b> For 7-1/2" System	<b>E9-7046</b>		<b>Outside Corner Face Cover</b> For 1-5/16" Glazing	<b>E9-7080</b>

\* Inside corners are available only in SSG.

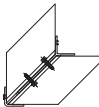
### FRAMING MEMBERS

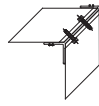

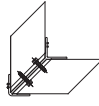

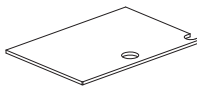















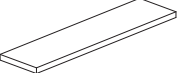

	<b>Flush Filler</b> Use with E9-7043	<b>E9-7044</b>		<b>Pressure Plate</b> For 1" Glazing	<b>AS-7054</b>
	<b>Flush Filler</b> Use with E9-7065	<b>E9-7066</b>		<b>1/4" Adaptor</b> For 1-5/16" Glazing	<b>E9-7749</b>

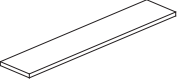
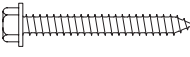
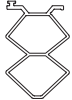
### ACCESSORIES

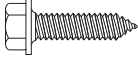
	<b>End Dam</b>	<b>E1-7002</b>		<b>Mullion Anchor</b> For 6" System	<b>E1-7004</b>
	<b>Interlocking Mullion Clip</b> For 7-1/2" system Use with E9-7002	<b>E1-7003</b>		<b>Jamb Anchor</b> For 6" System	<b>E1-7005</b>
	<b>Interlocking Mullion Clip</b> For 6" system Use with E9-7062	<b>E1-7072</b>		<b>Mullion Anchor</b> For 7-1/2" System	<b>E1-7024</b>
	<b>Corner Mullion Clip</b> Use with E9-7046 & E9-7069	<b>E1-7050</b>		<b>Jamb Anchor</b> For 7-1/2" System	<b>E1-7025</b>
	<b>Mullion Anchor Sleeve</b> For 7-1/2" system	<b>E1-7006</b>		<b>* 90° I.S. Corner Anchor</b> For 7-1/2" System	<b>E1-7088</b>
	<b>Mullion Reinforcement Clip</b> For 7-1/2" system	<b>E1-7007</b>		<b>90° O.S. Corner Anchor</b> For 7-1/2" System	<b>E1-7089</b>
	<b>Mullion Reinforcement Clip</b> For 6" system	<b>E1-7046</b>		<b>* 90° I.S. Corner Anchor</b> For 6" System	<b>E1-7090</b>
	<b>Setting Block Chair</b> For 1" Glazing	<b>E1-7009</b>		<b>90° O.S. Corner Anchor</b> For 6" System	<b>E1-7091</b>
	<b>Setting Block Chair</b> For 1-5/16" Glazing	<b>E1-7010</b>		<b>End Cap</b>	<b>E1-7008</b>

\* Inside corners are available only in SSG.

ACCESSORIES

	<b>Exterior Gasket</b>	<b>E2-7005</b>		<b>Captured Tongue Adaptor</b>	<b>E3-7017</b>
	<b>SSG Wiper Gasket *</b>	<b>E2-7009</b>		<b>Perimeter Spacer</b> For 1" Glazing	<b>E3-7008</b>
	<b>Interior Gasket</b>	<b>E2-7001</b>		<b>Perimeter Spacer</b> For 1-5/16" Glazing	<b>E3-7015</b>
	<b>SSG Inside Corner Spacer Tape *</b>	<b>E2-0724</b>		<b>1/4" x 5/8" FHSMS</b> Type AB Zinc Plated Steel For Attachment of End Cap to Tongue adaptor	<b>FC-1410</b>
	<b>Air Water Seal Gasket</b>	<b>E2-7002</b>		<b>1/4" x 3/4" FHSMS</b> Type AB, Stainless Steel	<b>FC-1410-SS</b>
	<b>Horizontal Gasket</b>	<b>E2-7003</b>		<b>1/4" x 3/4" FHMS</b> Stainless Steel	<b>FM-2512-SS</b>
	<b>Setting Block</b> For 1" Glazing	<b>E2-7006</b>		<b>#12 x 1-1/4" HWHS</b> Stainless Steel, For Screw Spline Attachment	<b>HC-1220-SS</b>
	<b>Setting Block</b> For 1-5/16" Glazing	<b>E2-7018</b>		<b>#12 x 1-3/4" HWHSMS</b> Stainless Steel, For Screw Spline Attachment at Corner	<b>HC-1228-SS</b>
	<b>Sill Horizontal Weather Seal</b>	<b>E2-7016</b>		<b>1/4"-20 x 2" HHMS</b> Stainless Steel, For Pressure Plate Attachment	<b>HM-2532-SS</b>
	<b>Weather Seal Gasket</b>	<b>E2-7010</b>		<b>1/4 - 20 x 1" HWHMS</b> Type CA, Zinc Plated Steel	<b>HD-2516-W3</b>
	<b>Captured Joint Plug</b>	<b>E2-0102</b>		<b>#10 x 5/8" PHSMS</b> Type AB, Stainless Steel For Attachment of End Dam to Sill Starter	<b>PC-1010-SS</b>
	<b>SSG Corner Spacer</b>	<b>E2-7014</b>		<b>#10-24 x 1/2" FHUCMS</b> Stainless Steel For Attachment of End Cap to Vertical Mullion	<b>UF-1008-SS</b>
	<b>SSG Corner Tongue Adaptor *</b>	<b>E3-7011</b>		<b>#8 x 3/4" PHSMS</b> Type AB, Stainless Steel For Attachment of Face Cover to Press. Plate	<b>PC-0812-SS</b>

\* Inside corners are available only in SSG.

**UNIT ASSEMBLY**  
Please See Assembly  
Instructions Manual

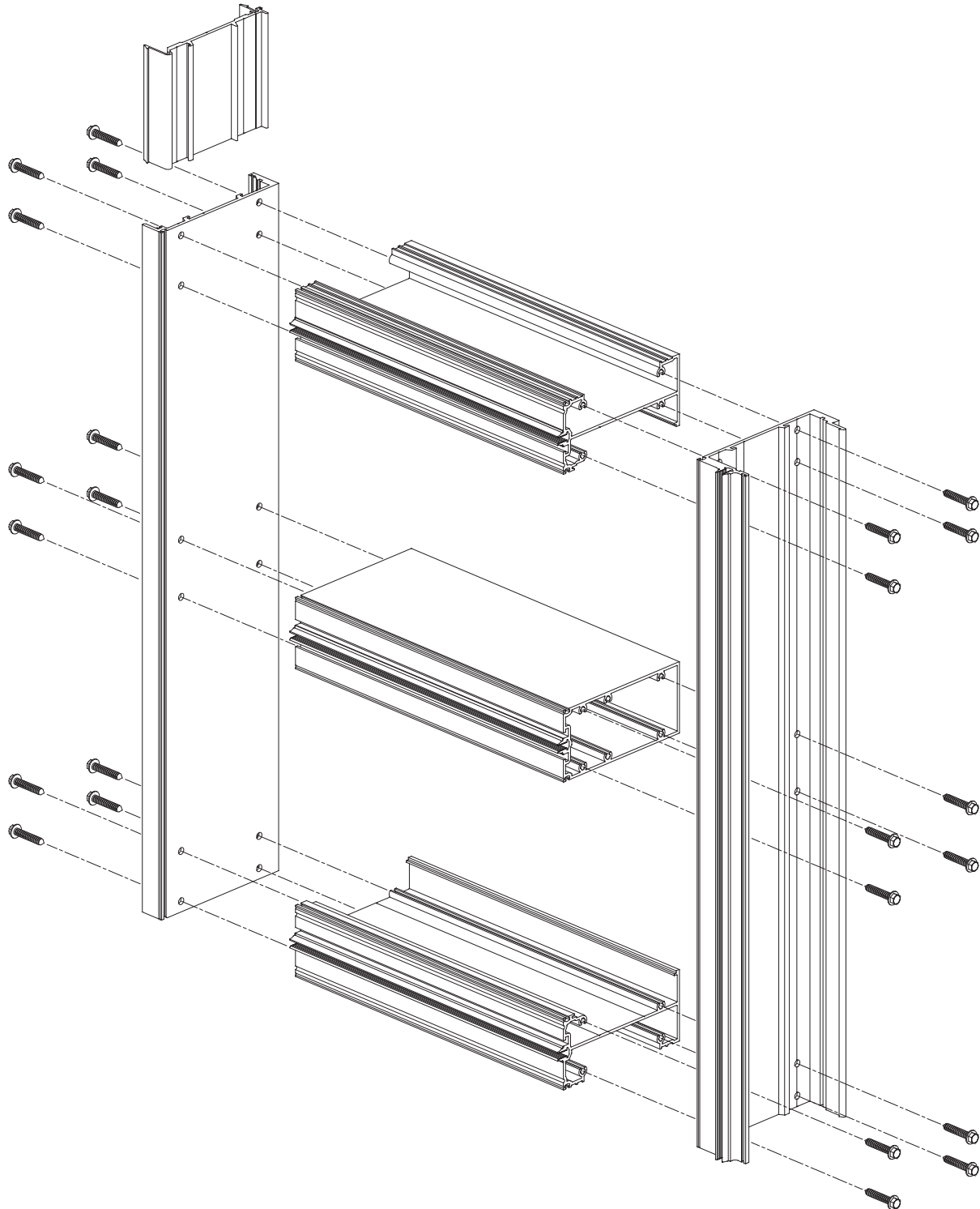



### INSTALLATION

#### STEP 1

#### GENERAL NOTES:

#### Typical Unit Installation

Units are typically rotated into place. Rotate the unit assembly into the receiving unit until the mullion halves engage. On shorter installations, the units may be installed from the side, eliminating the need for rotation.

See **Details 1**.

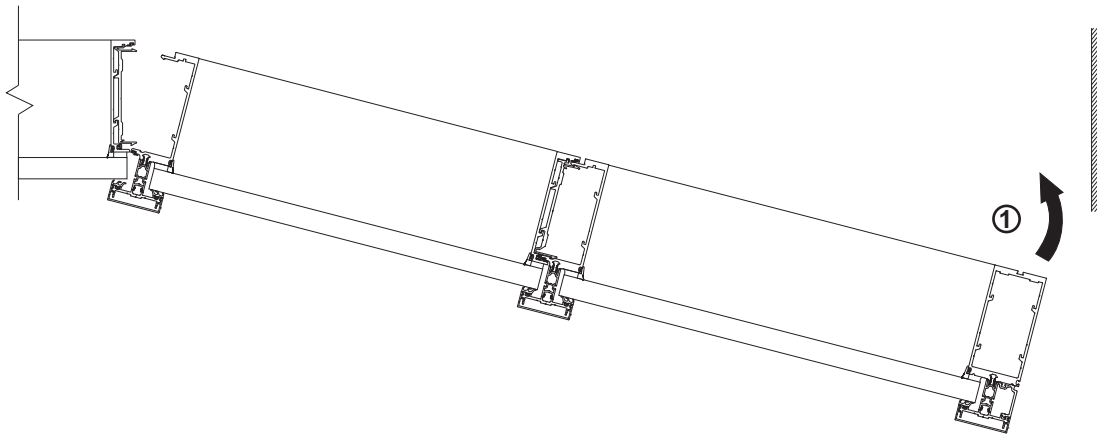

**OPTIONAL ROTATION OF TWO FINAL LADDER ASSEMBLIES**

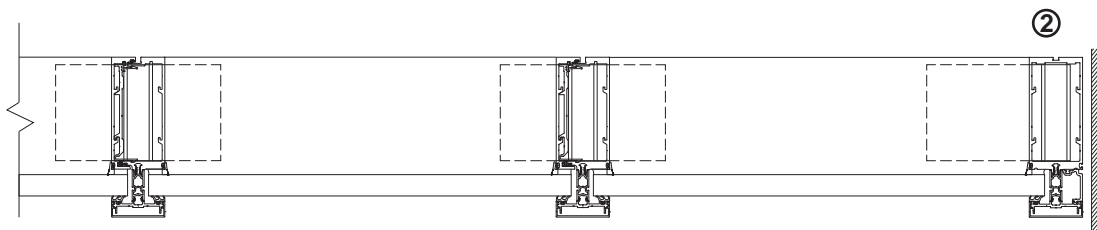

**COMPLETED INSTALLATION**

#### *Detail 1*

**INSTALLATION**

**STEP 1**

**GENERAL NOTES (Continued):**

**Pre Installation Sealant Note:**

-Just prior to installing next unit, apply sealant to the E9-7095 mullion from bottom of mullion to 8" above horizontal air/water seal gasket. Add sealant to the top of the E9-7095 mullion as shown. Also just prior to installing the next unit, apply sealant to the top side of the the end cap.

See **Detail 2**.

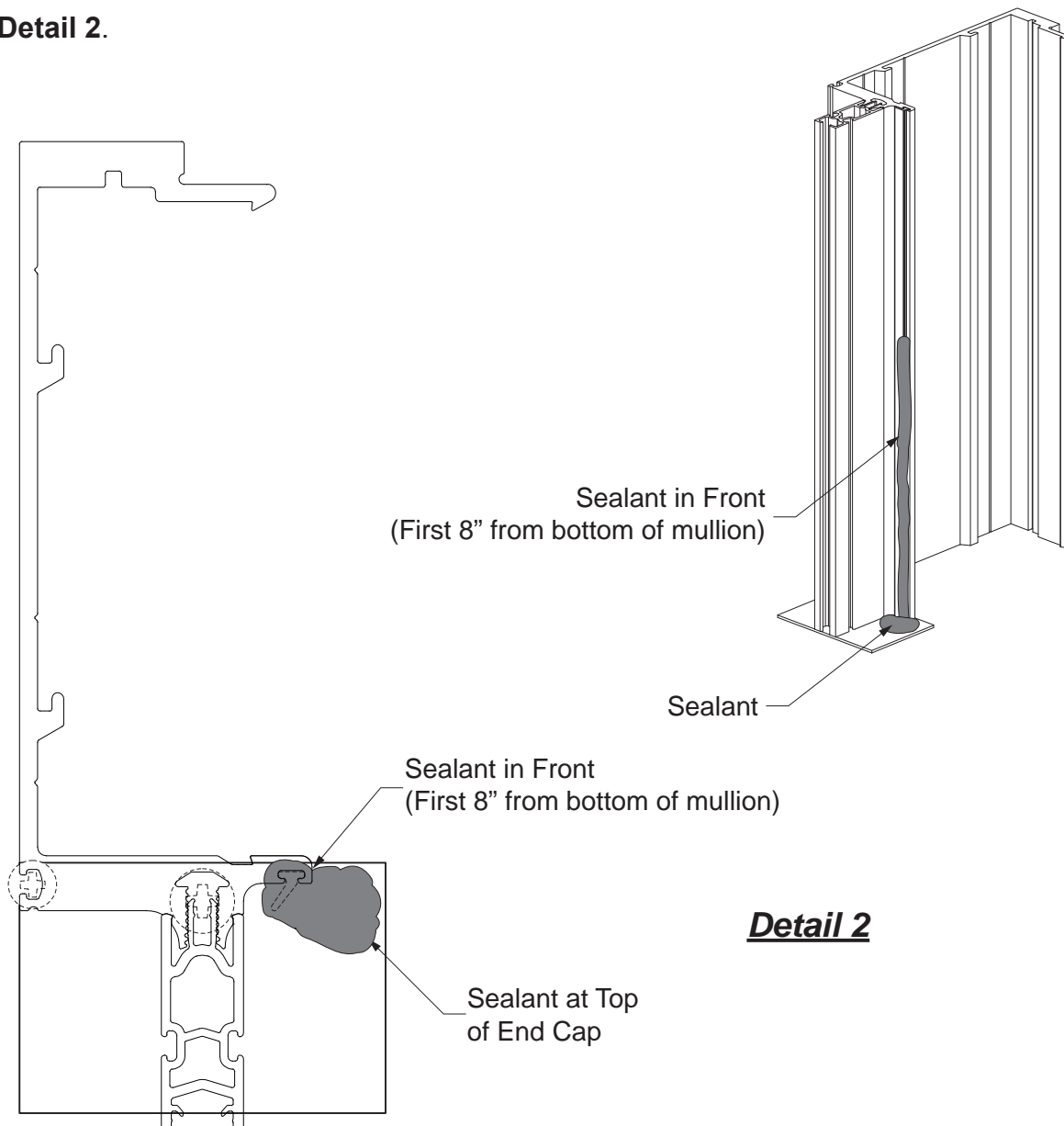

**Detail 2**

### INSTALLATION

#### STEP 2 UNIT ANCHORING METHOD

##### Using Mullion End Anchors:

YUW 750 XT has two possible end anchoring conditions: "T", and "F".

- "T" anchors are used with intermediate verticals at the head and sill.
- "F" anchors are used with jamb mullions at the head and sill.

Ladders should be pre-assembled with end anchors, and steel or aluminum reinforcing if necessary.

To install units into place, pre-attach the "F" anchor and the "T" anchor into the left jamb ladder assembly by temporarily taping them to the ladder assembly.

Temporary wood planks at the center may be used to shim the unit to approximate height until final shims are placed under the vertical mullion. Place fixed hard shims under vertical mullion halves after ladder assemblies are located.

See **Detail 3**.

T & F anchors should be pre-drilled for anchor fasteners according to approved shop drawings or engineering calculations.

**Note:** When installing units, check overall frame width every fifth mullion as the wall is installed. A buildup of cumulative tolerance errors may occur, resulting in excessive DLO spacing.

After units are plum and level, anchor end anchors as you progress from one unit to the next down the elevation.

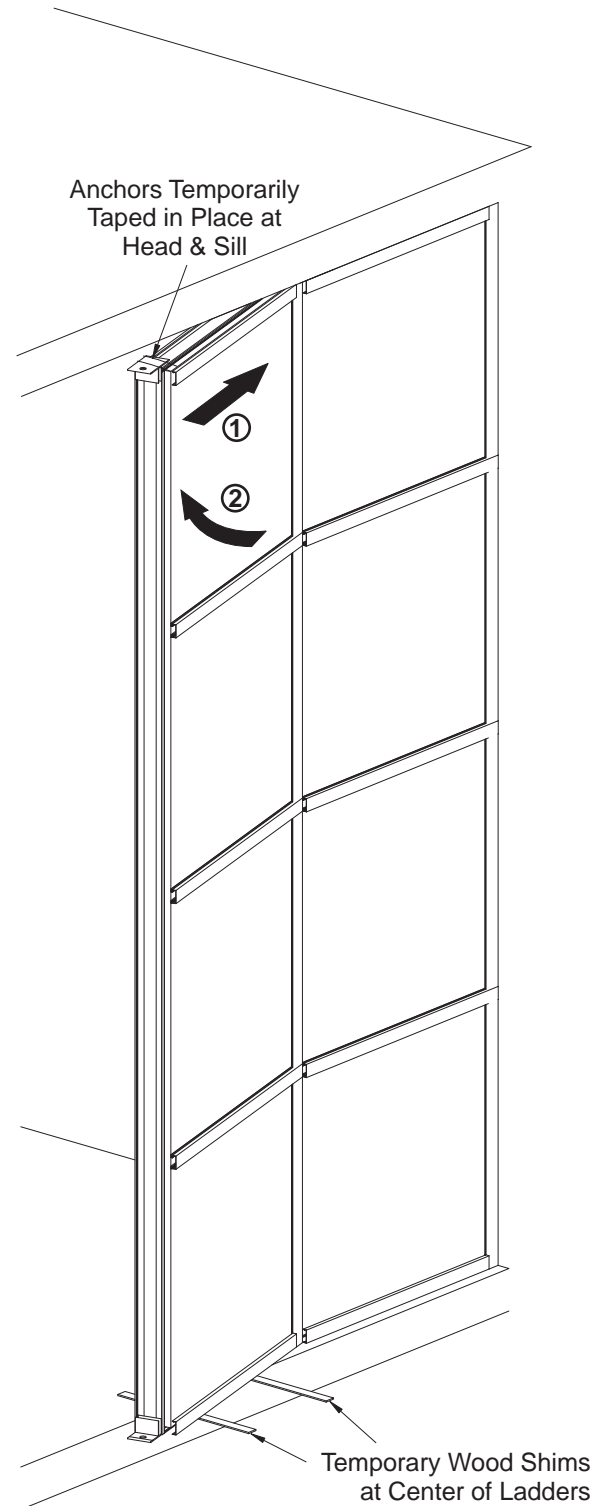

**Detail 3**

**INSTALLATION**

**STEP 3  
APPLY PERIMETER SEALANT**

- Please note the detailed perimeter seal location. Primary Seal must be applied @ detailed location.
  - Clean the area around the perimeter of the frame with cleaner and method approved by sealant manufacturer.
  - Push in backer rod between the perimeter of the frame and the substrate about 1/2".
  - Apply a quality sealant to the perimeter of the frame.
  - Tool the sealant making sure that sealant provides a watertight joint.
- See **Detail 4**.

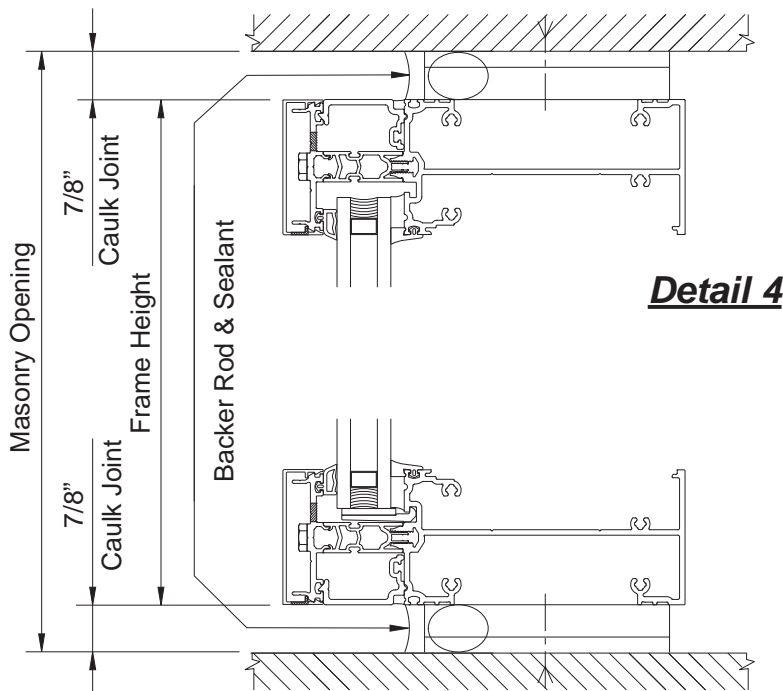

**Detail 4**

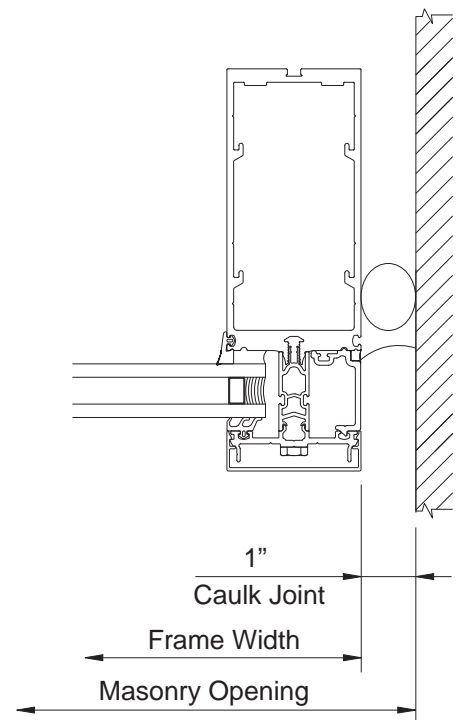

**STEP 4  
INSTALL FLAT FILLERS**

- Snap in flat fillers into the head and sill members, if required. See **Detail 5**.

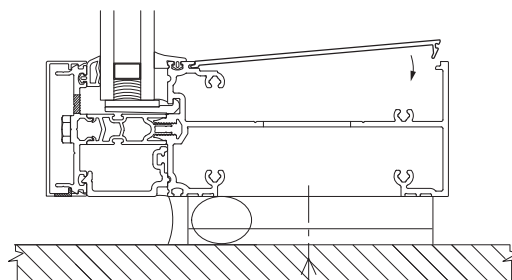

**Detail 5**



 **YKK AP America Inc.**

270 Riverside Parkway

Suite 100

Austell, Georgia 30168

[www.ykkap.com](http://www.ykkap.com)