

**YUW 750 XT
4 Side SSG - Window Wall**

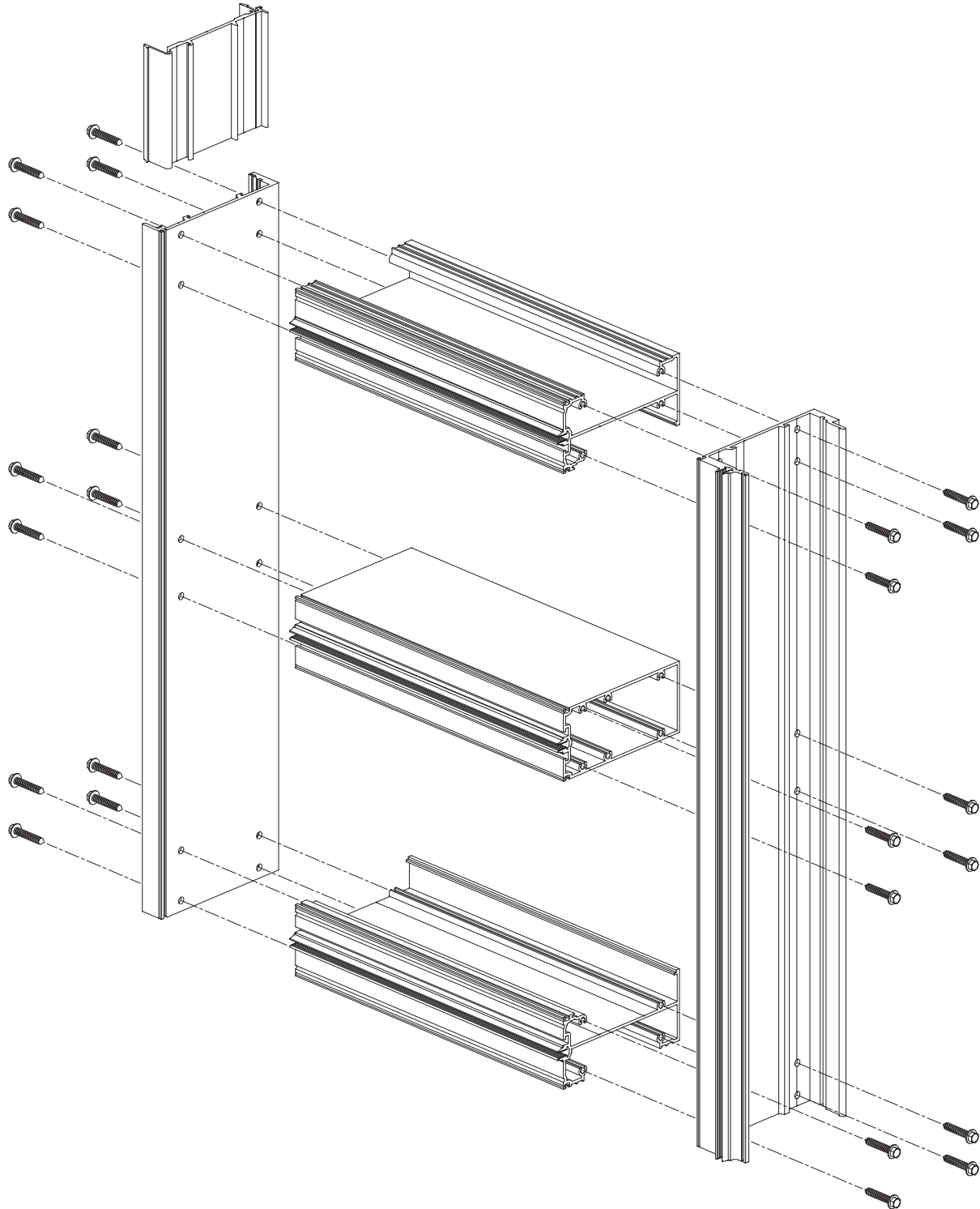

Installation Manual



TABLE OF CONTENTS

Installation Notes Page ii
Notice for SSG Curtain Wall Installation Page iii

PARTS DESCRIPTION

YUW 750 XT Framing Members Page 1 & 2
YUW 750 XT Accessories Page 2 to 4

INSTALLATION

Unit Installation Page 6
Pre-installation Sealant Note Page 7
Unit Anchoring Method Page 8
Apply Perimeter Sealant Page 9
Install Flat Fillers Page 9

Installation Notes

1. Do not drop, roll or drag boxes of aluminum framing. Move and stack boxes with proper support to prevent distortion. If fork lifts are used, be especially careful about striking the boxes when lifting or moving.
2. Store in a dry, out of the way area. If rain exposure, condensation or any water contact is likely, then all packaging material should be removed. Wet packaging materials will discolor and may stain aluminum finishes and paints.
3. All materials should be checked for quality and quantity upon receipt, YKK AP must be notified immediately of any discrepancies in shipment. Check to make sure that you have the required shims, sealants, supplies and tools necessary for the installation.
4. Carefully check the openings and surrounding conditions that will receive your material. Remember, if the construction is not per the construction documents, it is your responsibility to notify the general contractor in writing. Any discrepancies must be brought to the general contractor's attention before you proceed with the installation.
5. Gather your shop drawings, materials, packing list, and this installation manual. Carefully review parts location, the sequence it goes therein, when you glaze it and how you seal it. Installation instructions are of a general nature and may not cover every condition you will encounter. The shop drawings and/or installation manuals were prepared specifically for the product.
6. Any material substitutions must be of equal or greater quality.
7. Make certain that material samples have been sent for compatibility testing for all manufacturer's sealants involved. Make certain sealants have been installed in strict accordance with the manufacturer's recommendations and specifications.
8. Remember to isolate, in an approved manner, all aluminum from uncured masonry or other incompatible materials.
9. System-to-structure fasteners are not supplied by YKK AP. Fasteners called out on shop drawings are to indicate minimum sizes for design loading.
10. If any questions arise concerning YKK AP products or their installation, contact YKK AP for clarification before proceeding.
11. YKK AP storefront and/or curtain wall framing is typically completed before drywall, flooring and other products which may still be in process. Take the extra time to wrap and protect the work produced.
12. Cutting tolerances are plus zero, minus one thirty second unless otherwise noted.
13. Check our website, www.ykkap.com, for the latest installation manual update prior to commencing work.

Important Notice for SSG Curtain Wall Systems:

In order to properly perform and to maintain structural integrity, in addition to all other installation requirements, structurally glazed curtain wall systems rely specifically upon effective and appropriate structural sealant selection and installation.

It is the responsibility of the glazing contractor to take all steps to ensure the installed structural sealant is capable of meeting all applicable project requirements in accordance with industry standards. Such steps on each project may include, but are not limited to, design reviews, formal adhesion testing, project specification compliance, validating applications, field testing, auditing, sealant design strength analysis, and the quality control review of the installation and surrounding conditions.

Subject to project specific design pressures, requirements, and/or specifications, the structural sealant that is used between the glass and framing system must be capable of withstanding tensile and shear stresses imposed by the curtain wall without failing adhesively or cohesively.

The structural sealant's capability to withstand these stresses are dependent on several factors including, but not limited to, type of structural sealant, method of application (i.e. cleaning, primer), construction of glazing material (i.e. insulating glass unit (IGU), other infill, and finish of framing (i.e. anodizing, paint).











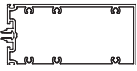
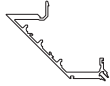
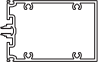

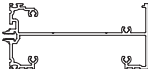
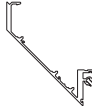
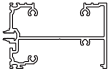



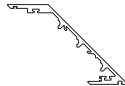

- Adhesive failure occurs when sealant pulls away from substrate cleanly, leaving no sealant material behind.
- Cohesive failure occurs when sealant breaks or tears within itself but does not separate from each substrate because sealant-to-substrate bond strength exceeds sealant's internal strength.

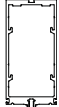
The IGU and/or other infill must be constructed for installation into structurally sealant glazed curtain walls. Notify the manufacturer or fabricator of the IGU and/or infill and advise of the product's application into 2 or 4-sided structurally sealant glazed curtain walls along with the project's design requirements so that appropriate fabrication steps are taken.

Secondary Notice for SSG Curtain Wall Systems:

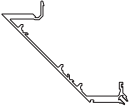
Standard product details and system offering supports single and twin span applications only. For multi-span applications or elevation configurations that require the application of vertical expansion components, please contact YKK AP engineering for review.

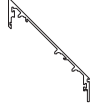
FRAMING MEMBERS

	Intermediate Horizontal For 7-1/2" System	E9-7097		Outside Corner Male Mullion For 6" System	E9-7068
	Intermediate Horizontal For 6" System	E9-7064		Outside Corner Female Mullion For 6" System	E9-7069
	Open Back Head/Sill For 7-1/2" System	E9-7099		Inside Corner Male Mullion For 7-1/2" System	E9-7047
	Open Back Head/Sill For 6" System	E9-7065		Inside Corner Female Mullion For 7-1/2" System	E9-7048
	Male Mullion Half For 7-1/2" System	E9-7095		Inside Corner Male Mullion For 6" System	E9-7070
	Female Mullion Half For 7-1/2" System	E9-7002		Inside Corner Female Mullion For 6" System	E9-7071
	Male Mullion Half For 6" System	E9-7061		Flush Filler Use with E9-7043	E9-7044
	Female Mullion Half For 6" System	E9-7062		Flush Filler Use with E9-7065	E9-7066
	Jamb Mullion For 7-1/2" System	E9-7098		Pressure Plate For 1" Glazing	AS-7054
	Jamb Mullion For 6" System	E9-7063		Pressure Plate For 1-5/16" Glazing	AS-7057
	Outside Corner Male Mullion For 7-1/2" System	E9-7045		Face Cover	E9-1206
	Outside Corner Female Mullion For 7-1/2" System	E9-7046		Glazing Adaptor used at 80 psf	E9-7749

















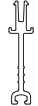
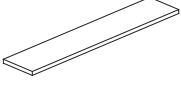





FRAMING MEMBERS

	SSG Jamb Spacer (Optional) For 1-5/16" Glazing	E9-4597		SSG Jamb Adaptor Base	E9-7053
	SSG Jamb Adaptor Base (Optional)	E9-7052			

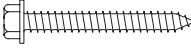

ACCESSORIES

	End Dam	E1-7002		Mullion Anchor For 6" System	E1-7004
	Interlocking Mullion Clip Use with E9-7002 For 7-1/2" system	E1-7003		Jamb Anchor For 6" System	E1-7005
	Interlocking Mullion Clip Use with E9-7062 For 6" system	E1-7072		Mullion Anchor For 7-1/2" System	E1-7024
	Mullion Reinforcement For 7-1/2" System	E1-7007		Jamb Anchor For 7-1/2" System	E1-7025
	Mullion Reinforcement For 6" System	E1-7046		90° I.S. Corner Anchor For 7-1/2" System	E1-7088
	Corner Mullion Clip Use with E9-7046 & E9-7069	E1-7050		90° O.S. Corner Anchor For 7-1/2" System	E1-7089
	Mullion Anchor Sleeve For 7-1/2" system	E1-7006		90° I.S. Corner Anchor For 6" System	E1-7090
	SSG Setting Block Chair For 1" Glazing	E1-7067		90° O.S. Corner Anchor For 6" System	E1-7091
	SSG Setting Block Chair For 1-5/16" Glazing	E1-7011		End Cap	E1-7008

ACCESSORIES

	Interior Gasket	E2-7001		Captured Tongue Adaptor	E3-7017
	Air Water Seal Gasket	E2-7002		SSG Tongue Adaptor For 1" Glazing	E3-7013
	Horizontal Gasket	E2-7003		SSG Tongue Adaptor For 1-5/16" Glazing	E3-7011
	SSG Setting Block For 1" Glazing	E2-7011		SSG Corner Tongue Adaptor For 1-5/16" Glazing	E3-7020
	SSG Setting Block For 1-5/16" Glazing	E2-7017		Perimeter Spacer For 1" Glazing	E3-7008
	SSG Vertical Rainsreen Gasket	E2-7009		Perimeter Spacer For 1-5/16" Glazing	E3-7015
	SSG Corner Rainsreen Gasket	E2-7015		PVC End Cap For Face Cover	E3-7024
	Weather Seal Gasket	E2-7010		#10 x 1/2" PHSMS Type AB, Stainless Steel For Attachment of Angle to Jamb	PC-1008-SS
	Captured Joint Plug	E2-0102		1/4" x 5/8" FHMS Type AB, Zinc Plated Steel For Attachment of End Cap to Vertical Tongue Adaptor	FC-1410
	Exterior Gasket	E2-7005		1/4" x 3/4" FHMS Stainless Steel	FM-2512-SS
	1/4" x 1/4" Glazing Spacer Tape	E2-0724		#12 x 1-1/4" HWHS Stainless Steel For Screw Spline Attachment	HC-1220-SS
	SSG Corner Spacer	E2-7014		#12 x 1-2/4" HWHSMS Stainless Steel For Screw Spline Attachment at Corner	HC-1228-SS
	3/4" Spacer Sponge	E2-0725		1/4"-20 x 2" HHMS Stainless Steel For Pressure Plate Attachment	HM-2532-SS

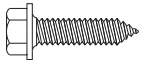
ACCESSORIES

 <p>1/4 - 20 x 1" HWHMS Type CA, Zinc Plated Steel</p>	<p>HD-2516- W3</p>	 <p>#10 x 5/8" PHSMS Type AB, Stainless Steel For Attachment of End Dam to Sill Starter</p>	<p>PC-1010- SS</p>
 <p>#10-24 x 1/2" FHUCMS Stainless Steel For Attachment of End Cap to Vertical Mullion</p>	<p>UF-1008- SS</p>		

UNIT ASSEMBLY

Please See Assembly
Instructions Manual

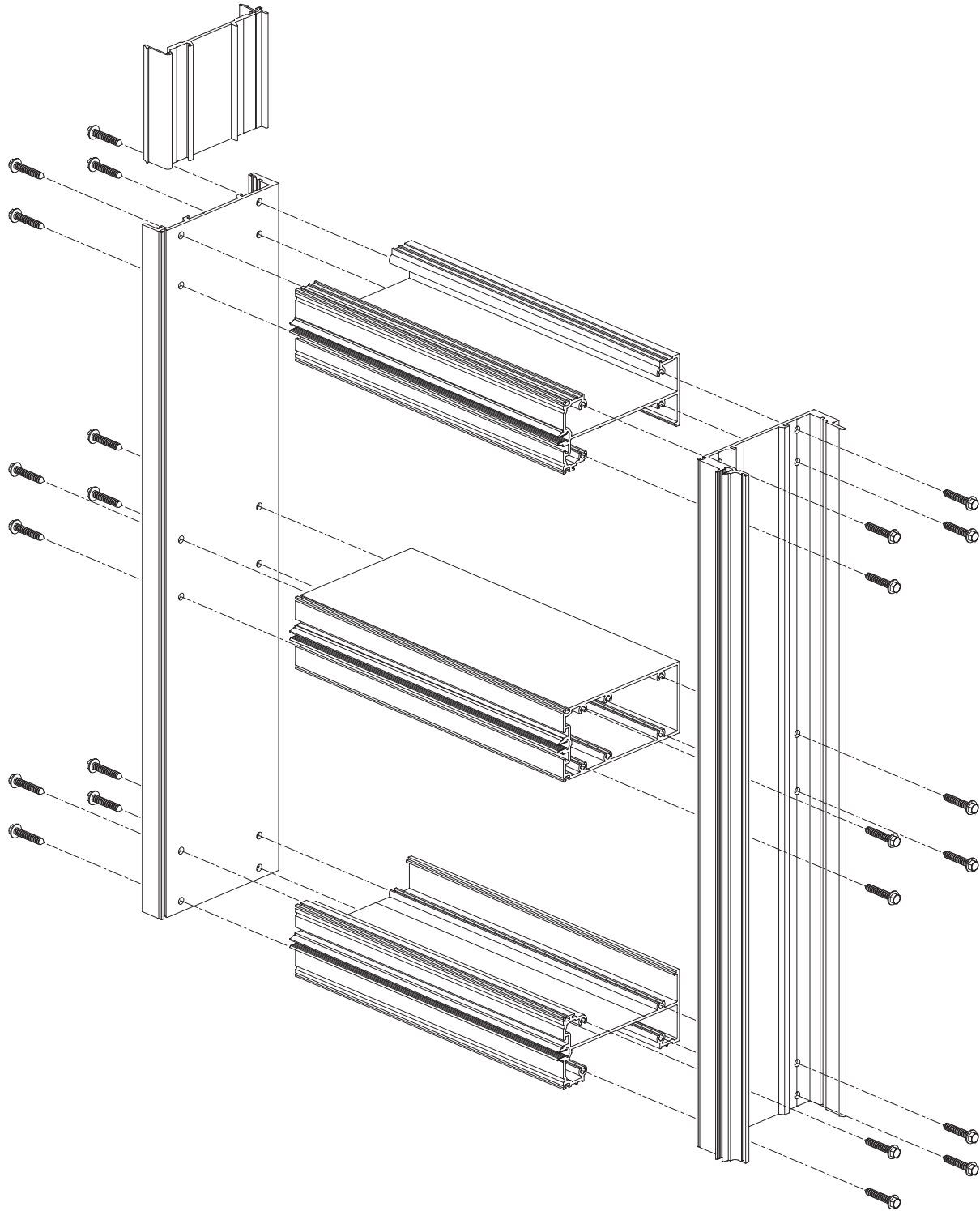

INSTALLATION**STEP 1****GENERAL NOTES:****Typical Unit Installation**

Units are typically rotated into place. Rotate the unit assembly into the receiving unit until the mullion halves engage. On shorter installations, the units may be installed from the side, eliminating the need for rotation.

See **Details 1**.

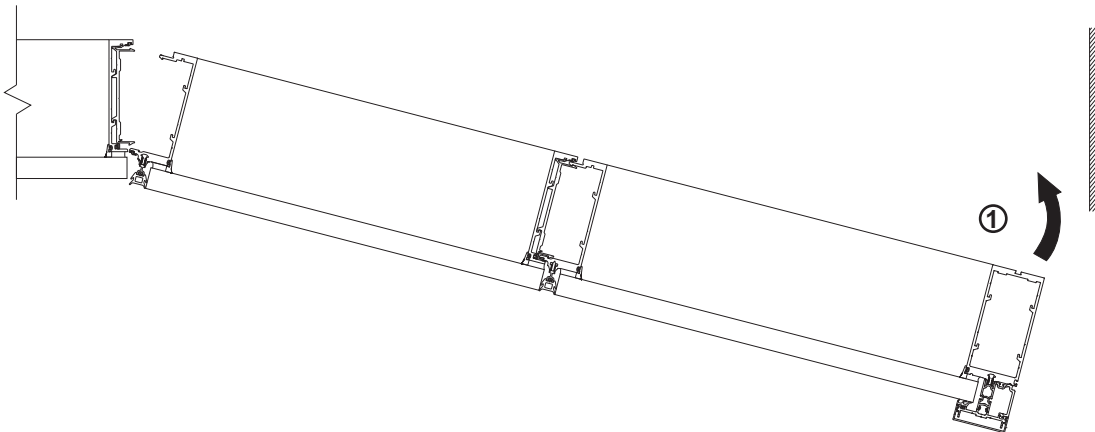
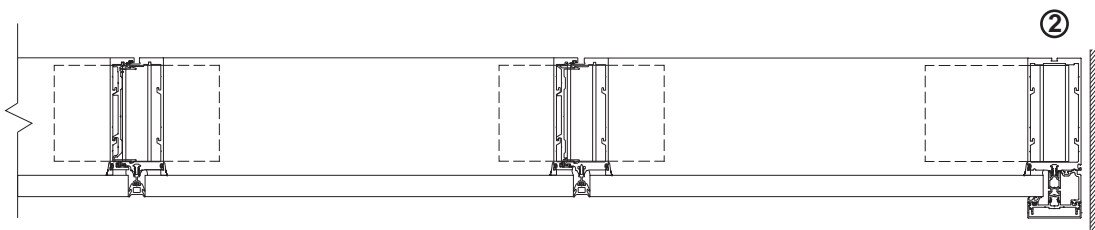
**OPTIONAL ROTATION OF TWO FINAL LADDER ASSEMBLIES****COMPLETED INSTALLATION****Detail 1**

INSTALLATION

STEP 1

GENERAL NOTES (Continued):

Pre-installation Sealant Note:

-Just prior to installing next unit, apply sealant to the E9-7095 mullion from bottom of mullion to 8" above horizontal air/water seal gasket. Add sealant to the top of the E9-7095 mullion as shown. Also just prior to installing the next unit, apply sealant to the top side of the the end cap.

See **Detail 2**.

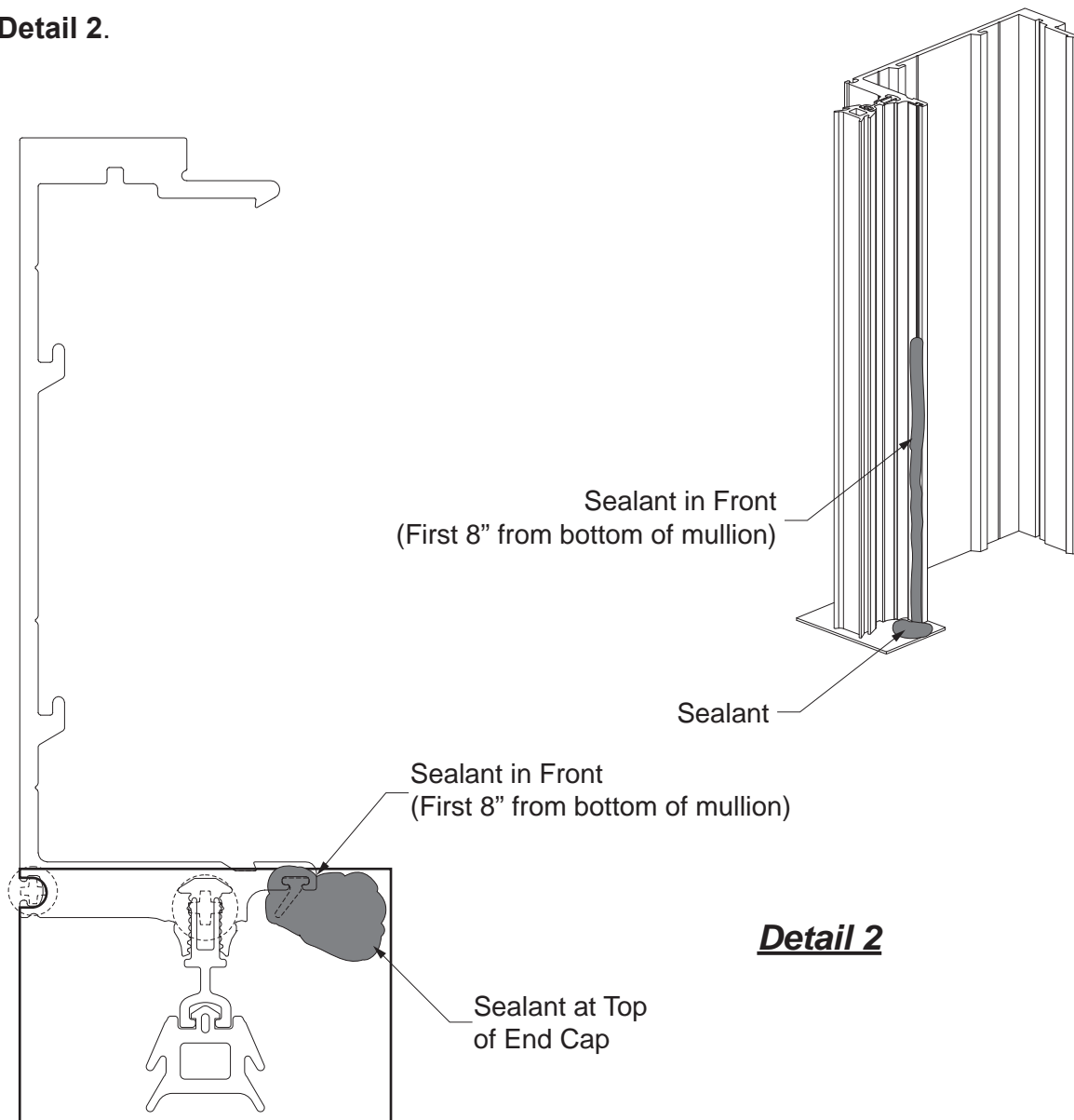

INSTALLATION

**STEP 2
UNIT ANCHORING METHOD**

Using Mullion End Anchors:

YUW 750 XT has two possible end anchoring conditions: "T", and "F".

- "T" anchors are used with intermediate verticals at the head and sill.
- "F" anchors are used with jamb mullions at the head and sill.

Ladders should be pre-assembled with end anchors, and steel or aluminum reinforcing if necessary.

To install units into place, pre-attach the "F" anchor and the "T" anchor into the left jamb ladder assembly by temporarily taping them to the ladder assembly.

Temporary wood planks at the center may be used to shim the unit to approximate height until final shims are placed under the vertical mullion. Place fixed hard shims under vertical mullion halves after ladder assemblies are located.

See **Detail 3**.

T & F anchors should be pre-drilled for anchor fasteners according to approved shop drawings or engineering calculations.

Note: When installing units, check overall frame width every fifth mullion as the wall is installed. A buildup of cumulative tolerance errors may occur, resulting in excessive DLO spacing.

After units are plum and level, attach end anchors as you progress from one unit to the next down the elevation.

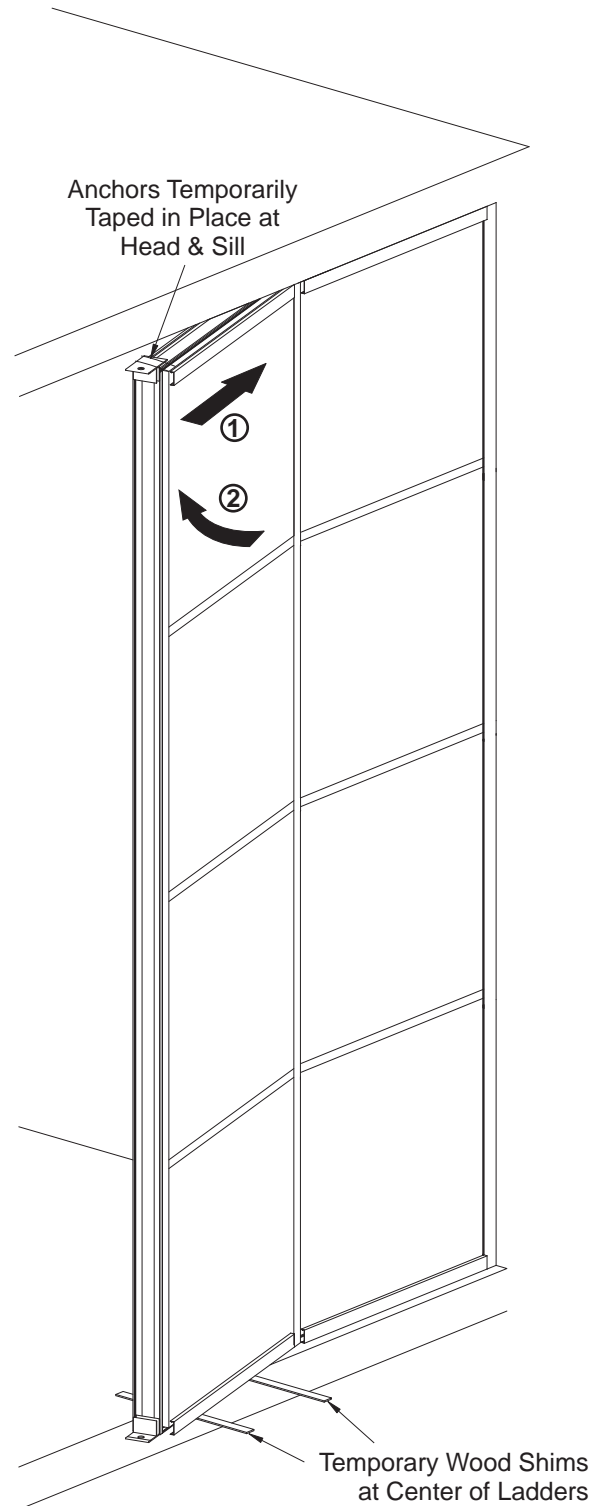

Detail 3

INSTALLATION

**STEP 3
APPLY PERIMETER SEALANT**

- Please note the detailed perimeter seal location. Primary Seal must be applied @ detailed location.
 - Clean the area around the perimeter of the frame with cleaner and method approved by sealant manufacturer.
 - Push in backer rod between the perimeter of the frame and the substrate about 1/2".
 - Apply a quality sealant to the perimeter of the frame.
 - Tool the sealant making sure that sealant provides a watertight joint.
- See **Detail 3**.

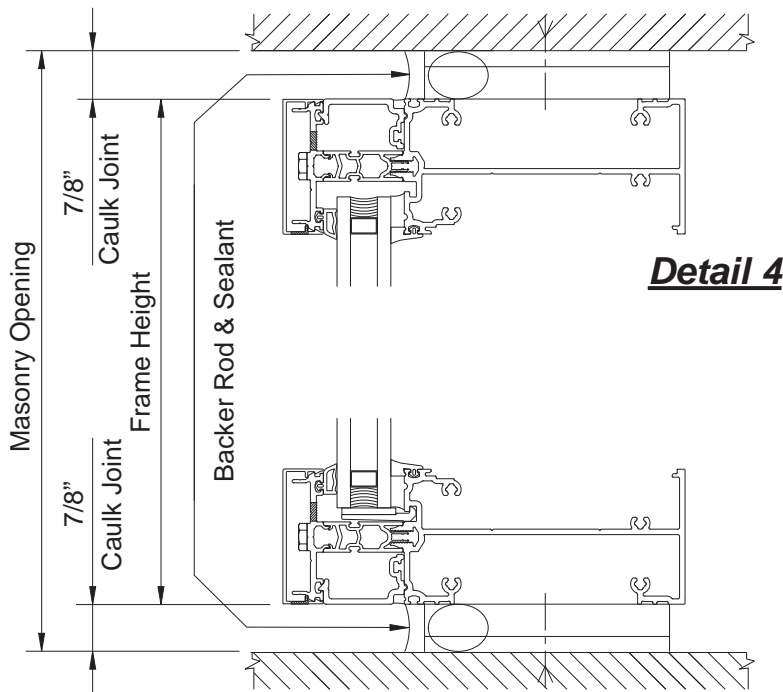

Detail 4

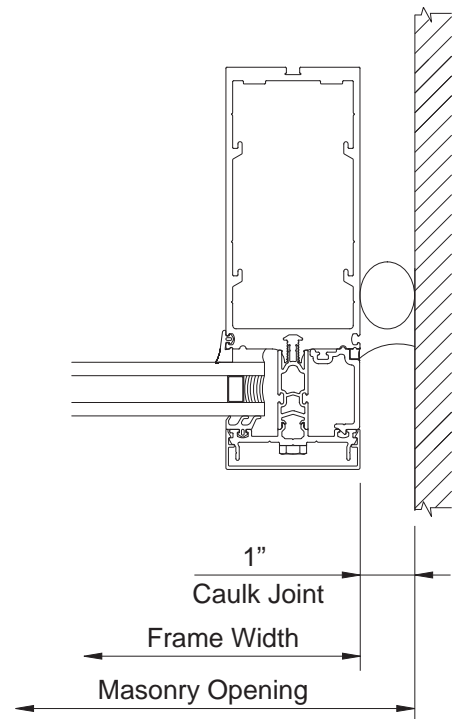

**STEP 4
INSTALL FLAT FILLERS**

- Snap in flat fillers into the head and sill members, if required. See **Detail 5**.

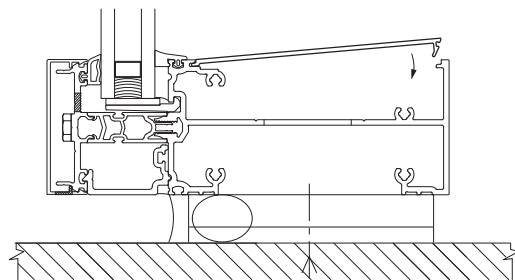

Detail 5

 **YKK AP America Inc.**

270 Riverside Parkway

Suite 100

Austell, Georgia 30168

www.ykkap.com