

INSTALLATION

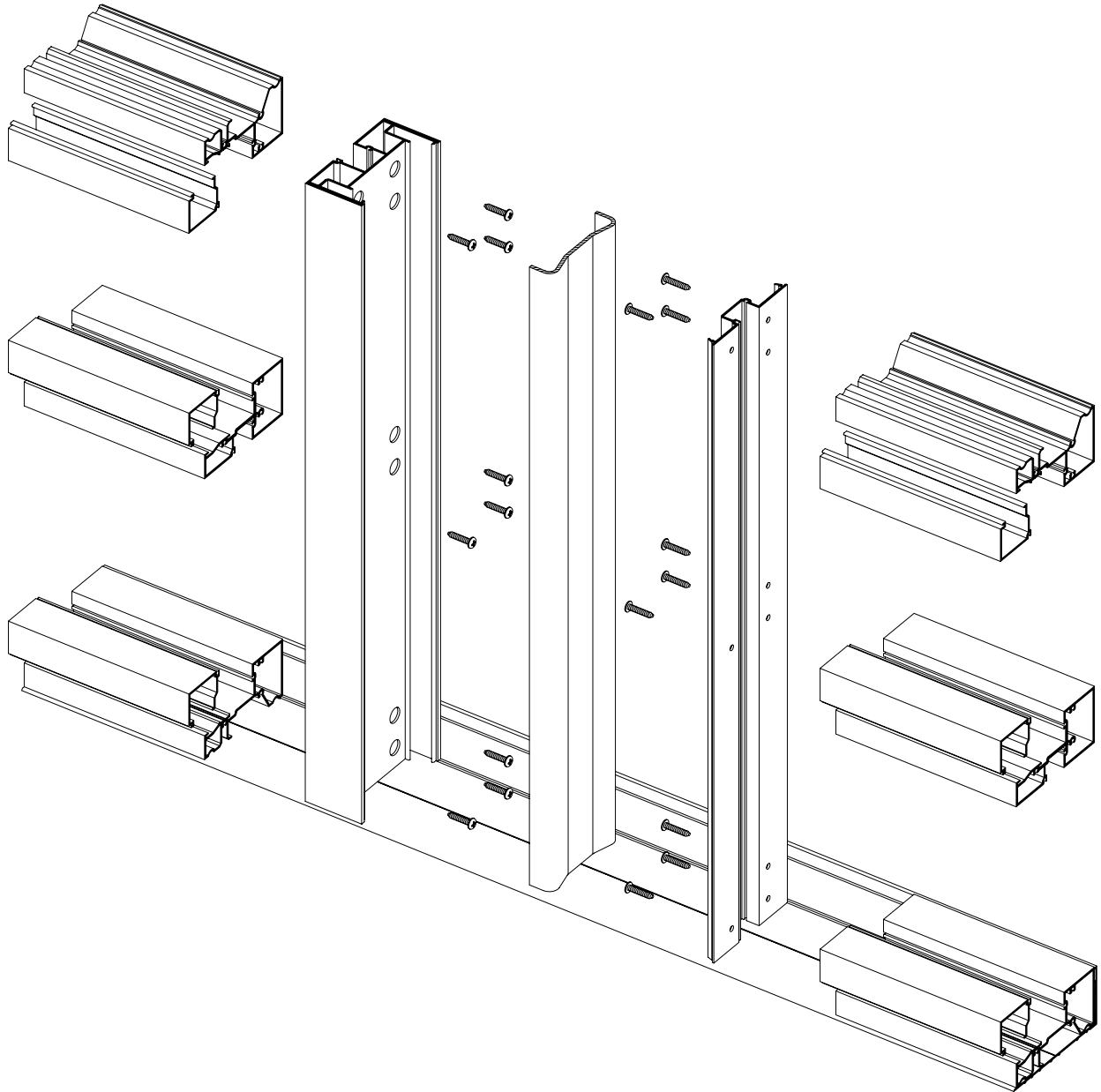

INSTRUCTIONS

Laws and building and safety codes governing the design and use of glazed entrance, window, and curtain wall products vary widely. Kawneer does not control the selection of product configurations, operating hardware, or glazing materials, and assumes no responsibility therefor.

Kawneer reserves the right to change configuration without prior notice when deemed necessary for product improvement.

© Kawneer Company, Inc. 2013

IR 500/501 INSTALLATION INSTRUCTIONS

These instructions provide the general fabrication, assembly, installation sequence and erection procedures for typical applications. They are intended to supplement the project shop drawings and/or published details.

SECTION	PAGE	
I	3	GENERAL NOTES *HANDLING, STORAGE & PROTECTION OF ALUMINUM *GENERAL INSTALLATION NOTES
II	4 - 9	PARTS IDENTIFICATION
III	10 - 23	SCREW SPLINE *FABRICATION *ASSEMBLY *INSTALLATION
IV	24 - 27	GLAZING
V	28	STRUCTURAL SILICONE SEAL
VI	29	EXPANSION MULLIONS
VII	29	STEEL REINFORCEMENT

Consult the KawneerDirect website for the latest updates to these instructions before beginning work on your project.

Laws and building and safety codes governing the design and use of glazed entrance, window, and curtain wall products vary widely. Kawneer does not control the selection of product configurations, operating hardware, or glazing materials, and assumes no responsibility therefor.

Kawneer reserves the right to change configuration without prior notice when deemed necessary for product improvement.
© Kawneer Company, Inc. 2013

HANDLING, STORING, AND PROTECTION OF ALUMINUM











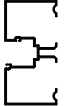



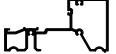



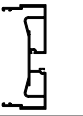

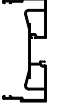
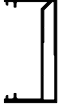
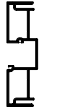
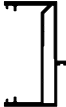
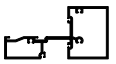

The material must be protected against damage. The following precautions are recommended to assure early acceptance of your products and workmanship.

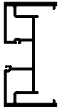
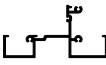
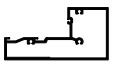
- A. HANDLE CAREFULLY** - Do not drop from the truck. Stack with adequate separation so material will not rub together. Store off the ground. Protect against elements and other construction trades. **Work safely - always wear proper personal protective equipment. Wear hand protection to prevent injury due to sharp edges of cut extrusions.**
- B. KEEP MATERIAL AWAY FROM WATER, MUD, AND SPRAY** - Prevent cement, plaster, or other materials from damaging the finish.
- C. PROTECT THE MATERIALS AFTER ERECTION** - Protect by wrapping with Kraft paper or by erecting Visqueen or canvas splatter screen. Cement, plaster, terrazzo, and other alkaline solutions and acid based materials used to clean masonry are very harmful to the finish and should be removed with water and mild soap IMMEDIATELY.

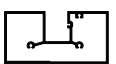
GENERAL INSTALLATION NOTES

The following practices are recommended for all installations:

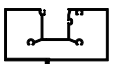













- A. CHECK SHOP DRAWINGS, INSTALLATION INSTRUCTIONS and GLAZING INSTRUCTIONS** to become thoroughly familiar with the project. The SHOP DRAWINGS take precedence and include specific details for the project. The INSTALLATION INSTRUCTIONS are of a general nature and cover the most common conditions.
- B. All materials are to be INSTALLED PLUMB, LEVEL, and TRUE.**
- C. All work should start from bench marks and/or column lines as established by the ARCHITECTURAL DRAWINGS and the GENERAL CONTRACTOR.** Check mullion spacing from ends of masonry opening to prevent dimensional build-up of day light opening.
- D. Make certain that the construction and openings which will receive your materials are in accordance with the contract documents.** If not, notify the GENERAL CONTRACTOR IN WRITING and resolve the differences before proceeding with your work.
- E. Isolate all aluminum to be placed directly in contact with uncured masonry or incompatible materials with a heavy coat of zinc chromate or bituminous paint.**
- F. Check all materials on arrival for quantity and be sure you have everything required to begin installation.**
- G. Sealants must be compatible with all materials with which they have contact, including other sealant surfaces.** Consult with sealant manufacturer for recommendations relative to joint size, shelf life, compatibility, priming, tooling, adhesion, etc.
- H. FASTENING** - "Fastening" means any method of securing one part to another or to adjacent materials. These instructions specify only those fasteners used within the system. Due to varying perimeter conditions and job performance requirements, perimeter anchor fasteners are not specified in these instructions. For perimeter anchor fastening, refer to the Shop Drawings or Engineering Calculations.
- I. CHECK OPENINGS** - Make certain that the opening which will receive your materials is in accordance with the contract documents. If not, notify the General Contractor in writing and resolve differences before proceeding with your work.
- J. BUILDING CODE** - Building and glazing codes governing the design and use of products vary widely. Kawneer does not control the selection of product configurations, operating hardware, or glazing materials, and assumes no responsibility for these design considerations. It is the responsibility of the owner, specifier, architect, general contractor and the installer to make these selections in strict conformance with all applicable codes.
- K. EXPANSION JOINTS** - Expansion joints and perimeter seals shown in these instructions and in the shop drawings are shown at a normal size. Actual dimensions may vary due to perimeter conditions and/or difference in metal temperature between the time of fabrication and time of installation, For example, a 12 foot unrestrained length of aluminum extrusion can expand or contract 3/32" over a 50 degree F temperature change. Any movement potential should be accounted for at the time of installation.
- L. FIELD TESTING** - It is recommended that a Water Hose Test be conducted once a sufficient portion of the frame is installed, glazed and caulked to ensure proper installation. The Water Hose Test shall be conducted in accordance with AAMA 501.2. In addition, larger projects should have periodic Water Hose Tests as additional precautionary measures.
- M. GASKET INVENTORY ROTATION** - These high quality rubber extrusions are coated with silicone lubricant, Silicone will dry over time leaving a white "chalky" residue. Please rotate your stock "FIRST IN - FIRST OUT". If the rubber becomes dry, you may use water ONE TIME to reconstitute the silicone, after that, use a soap water solution.

ILLUSTRATION	NO.	DESCRIPTION	ILLUSTRATION	NO.	DESCRIPTION
	575001	JAMB		575029	GLAZING ADAPTER SINGLE GLAZING
	575002	POCKET FILLER SHALLOW		575033	TRANSOM POCKET FILLER
	575003	HEAD / SILL		575035	POCKET FILLER DEEP
	575004	GLASS STOP		575044	POCKET FILLER SHALLOW SINGLE GLAZING
	575008	EXPANSION MULLION MALE HALF SINGLE GLAZING		575046	POCKET FILLER DEEP SINGLE GLAZING
	575009	EXPANSION MULLION MALE HALF		575050	OPEN BACK DOOR JAMB
	575010	EXPANSION MULLION FEMALE HALF		575051	OPEN BACK DOOR JAMB WITH EXTRUDED FIN
	575011	TUBULAR HORIZONTAL		575062	C.O.C. TRANSOM BAR (IR 500 / 501)
	575012	ONE-PIECE HEAD OPTIONAL		575162	H.W. C.O.C. TRANSOM BAR (IR 500 / 501)
	575013	VERTICAL MULLION		575057	OPTIONAL SILL (IR 500)
	575020	TRANSOM BAR		575058	COVER FOR OPTIONAL SILL (IR 500)
	575021	HEADER		575037	SILL FLASHING (HP SILL FLASHING 575157)
	575022	TRANSOM BAR WITH FIN		575060	TRANSOM BAR STOP - EXTERIOR (IR 500)
	575023	TRANSOM BAR WITH FIN		575061	TRANSOM BAR STOP - INTERIOR (IR 500)

Laws and building and safety codes governing the design and use of glazed entrance, window, and curtain wall products vary widely. Kawneer does not control the selection of product configurations, operating hardware, or glazing materials, and assumes no responsibility therefor.

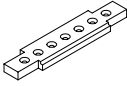
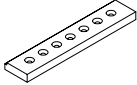
Kawneer reserves the right to change configuration without prior notice when deemed necessary for product improvement.













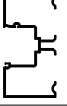



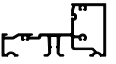

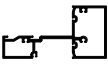

© Kawneer Company, Inc. 2013

ILLUSTRATION	NO.	DESCRIPTION	ILLUSTRATION	NO.	DESCRIPTION
	575056	GLASS POCKET EXTENSION		575110	STEEL REINFORCEMENT VERTICAL MULLIONS
	575063	CURVED HEAD (IR 500)		575111	STEEL REINFORCEMENT DOOR JAMB (IR 500)
	575064	CURVED HEAD COVER (IR 500)		575300	VERTICAL STEEL REINFORCEMENT #1
	575065	CURVED HEAD PRESSURE PLATE (IR 500 / 501)		575301	VERTICAL STEEL REINFORCEMENT #2
	451VG030	5/8" INFILL ADAPTER		575310	VERTICAL STEEL REINFORCEMENT
	069177	CONCEALED SCREW APPLIED DOOR STOP			
	575296	DOOR JAMB ANCHOR BLOCK (IR 500)			
	575297	DOOR JAMB ANCHOR BLOCK (IR 501)			
	575036	STRAP ANCHOR EXTRUSION FOR 575001/012/101/112			
	575212	3" STRAP ANCHOR FOR 575001/012/101/112			
	575213	6" STRAP ANCHOR FOR 575001/012/101/112			

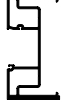
Laws and building and safety codes governing the design and use of glazed entrance, window, and curtain wall products vary widely. Kawneer does not control the selection of product configurations, operating hardware, or glazing materials, and assumes no responsibility therefor.

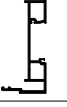



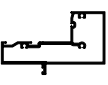
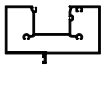





















Kawneer reserves the right to change configuration without prior notice when deemed necessary for product improvement.

© Kawneer Company, Inc. 2013

ILLUSTRATION	NO.	DESCRIPTION	ILLUSTRATION	NO.	DESCRIPTION
	575052	FASTENER SUPPORT FILLER		575133	TRANSOM POCKET FILLER
	575101	JAMB		575135	POCKET FILLER DEEP
	575102	POCKET FILLER SHALLOW		575157	SILL FLASHING
	575103	HEAD / SILL		575158	SILL
	575104	GLASS STOP		575159	SILL COVER
	575112	ONE PIECE HEAD OPTIONAL		575160	TRANSOM BAR STOP EXTERIOR (IR 501)
	575115	TUBULAR HORIZONTAL		575161	TRANSOM BAR STOP INTERIOR (IR 501)
	575116	H.W. VERTICAL MULLION (IR 501)		575163	CURVED HEAD EXTRUSION (IR 501)
	575117	EXPANSION MULLION MALE HALF		575164	CURVED HEAD COVER (IR 501) (USED W/ 575065 PRESSURE PLATE)
	575118	EXPANSION MULLION FEMALE HALF			
	575120	TRANSOM BAR			
	575122	TRANSOM BAR WITH FIN			
	575123	ONE PIECE TRANSOM BAR WITH FIN			

Laws and building and safety codes governing the design and use of glazed entrance, window, and curtain wall products vary widely. Kawneer does not control the selection of product configurations, operating hardware, or glazing materials, and assumes no responsibility therefor.



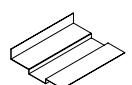

Kawneer reserves the right to change configuration without prior notice when deemed necessary for product improvement.
© Kawneer Company, Inc. 2013

ILLUSTRATION	NO.	DESCRIPTION	ILLUSTRATION	NO.	DESCRIPTION
	127011	1/4" SILICONE SPACER		127178	SILICONE SPLICE SLEEVE FOR STANDARD FLASHING 575037
	127012	5/16" SILICONE SPACER		575114	END DAM FOR 575037 SILL FLASHING
	027074	EXTERIOR STANDARD PUSH-ON GASKET		575208	END DAM FOR 575157 SILL FLASHING
	027077	EXTERIOR HEAVY PUSH-ON GASKET		575203	CURVED HEAD ANCHOR CLIP (IR 500/501)
	127146	INTERIOR FIXED GASKET (IR 500)		175313	WATER DEFLECTOR (IR 500)
	127147	EXTERIOR GLAZING GASKET (IR500)		127015	SETTING BLOCK (IR 500)
	127121	INTERIOR FIXED GASKET (IR 501)		127137	TRANSOM BAR SETTING BLOCK (IR 500)
	127127	EXTERIOR GLAZING GASKET (IR 501)		451105	WATER DEFLECTOR (IR 501)
	127191	PUSH-IN GASKET (IR501)		127070	SETTING BLOCK (IR 501)
	027806	FIXED GASKET		127138	TRANSOM BAR SETTING BLOCK (IR 501)
	027900	3/16" GLAZING WEDGE		027916	PERIMETER SPACER AT CURVED HEADER
	163303	THERMAL BREAK		027908	"W" SIDE BLOCK - IR500
	127120	0.250" x 0.375" FOAM TAPE AT SILL		422434	"W" SIDE BLOCK - IR501
	575202	SPLICE SLEEVE FOR HP FLASHING 575157			

Laws and building and safety codes governing the design and use of glazed entrance, window, and curtain wall products vary widely. Kawneer does not control the selection of product configurations, operating hardware, or glazing materials, and assumes no responsibility therefor.

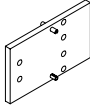
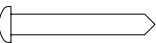
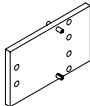
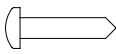
Kawneer reserves the right to change configuration without prior notice when deemed necessary for product improvement.

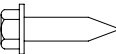
© Kawneer Company, Inc. 2013

ILLUSTRATION	NO.	DESCRIPTION	ILLUSTRATION	NO.	DESCRIPTION
	028260	APPLIED DOOR STOP #8 x 3/8" PHTF "AB"		575200	DRILL JIG (IR 500)
	128112	CURVED HEAD SPLINE SCREW #12 x 1-1/2" F Active		575201	DRILL JIG (IR 501)
	128267	SPLINE SCREW #12 X 1" PHTF "AB"			
	128271	STEEL ATTACHMENT SCREW #12 x 5/8" PHTF "B"			
	128396	SILL TO FLASHING SCREW #12 X 7/16" PHTF "B"			
	128406	PRESSURE PLATE SCREW 1/4" x 1" HHTF "AB"			
	128910	T-BAR GLASS STOP SCREW #10 x 1/2" FHTF "B" (UC)			

Laws and building and safety codes governing the design and use of glazed entrance, window, and curtain wall products vary widely. Kawneer does not control the selection of product configurations, operating hardware, or glazing materials, and assumes no responsibility therefor.

Kawneer reserves the right to change configuration without prior notice when deemed necessary for product improvement.
© Kawneer Company, Inc. 2013

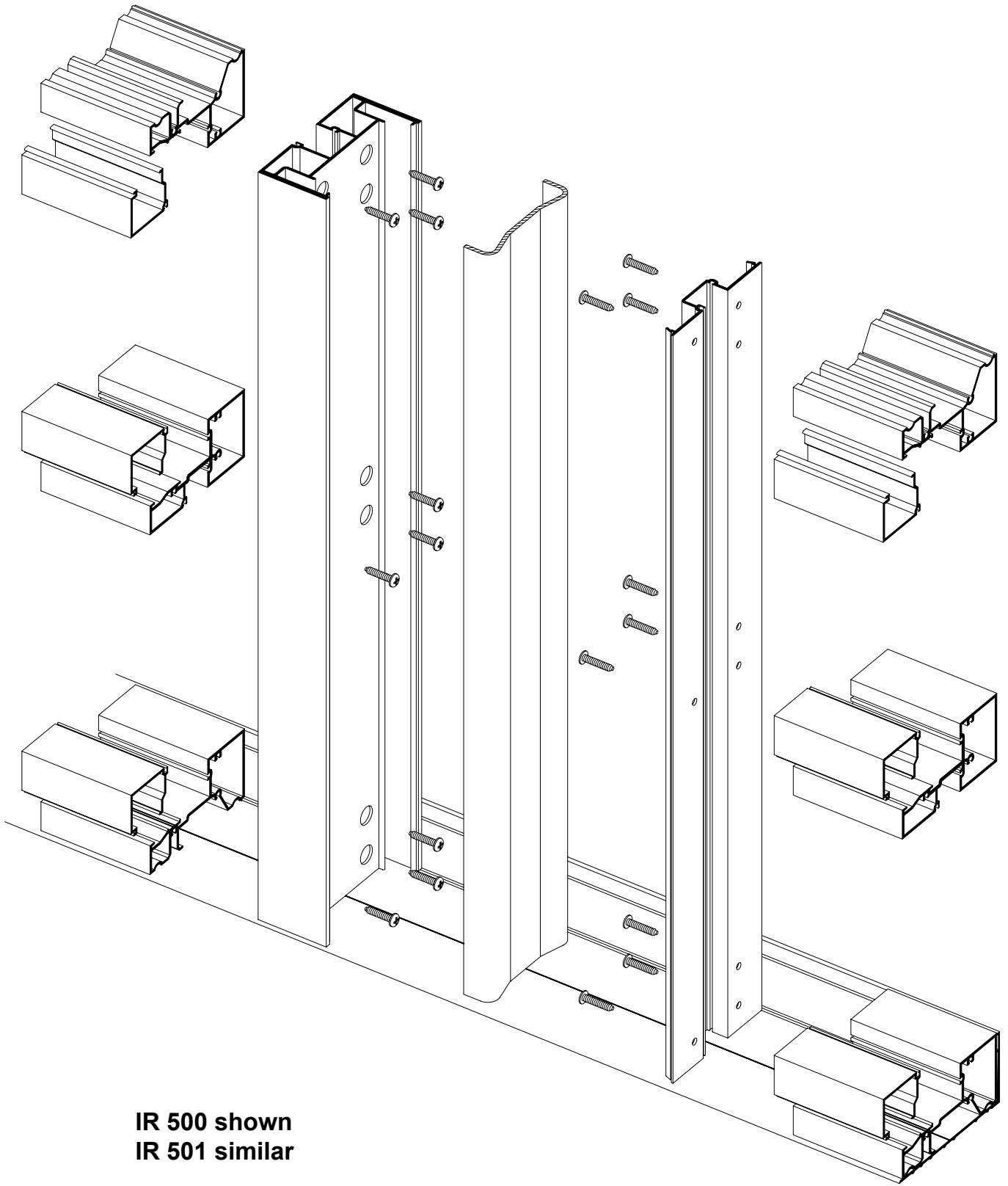

**IR 500 shown
IR 501 similar**

Laws and building and safety codes governing the design and use of glazed entrance, window, and curtain wall products vary widely. Kawneer does not control the selection of product configurations, operating hardware, or glazing materials, and assumes no responsibility therefor.

Kawneer reserves the right to change configuration without prior notice when deemed necessary for product improvement.

© Kawneer Company, Inc. 2013

SCALE: 3" = 1'-0"

The Screw Spline method of fabrication and erection permits pre-assembly of single units in the shop or at the job site. These units are then erected by mating the male mullion half of one unit with the female mullion half of a unit already installed.

Note: 5/8" infill shown, 1/4" and 9/16" infill similar.

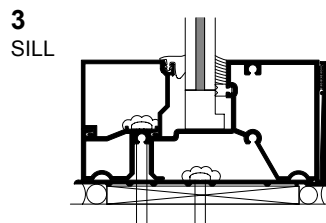
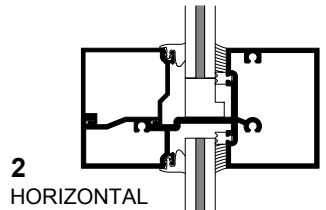
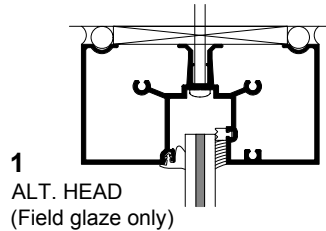
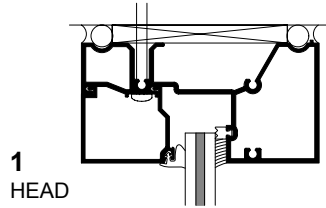
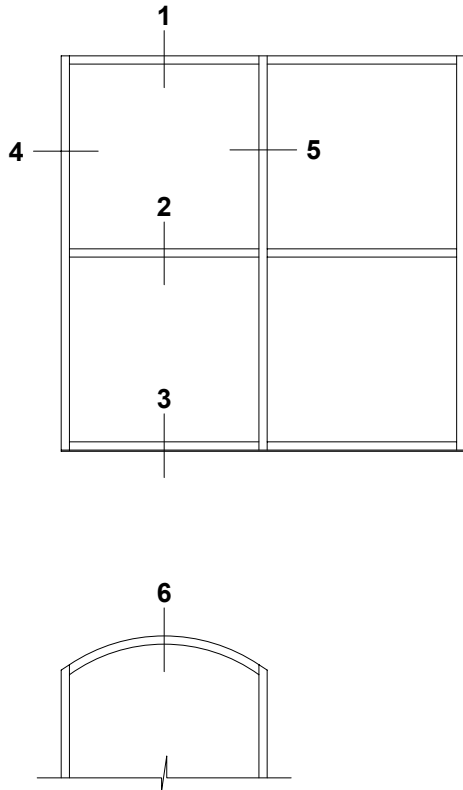

STRAP ANCHOR

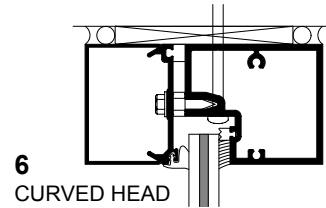
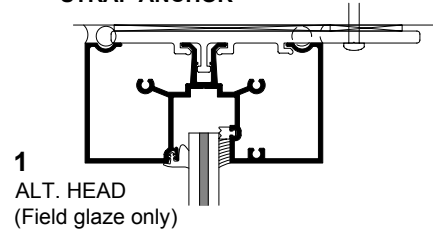

CURVED HEAD WITH ATTACHMENT CLIP

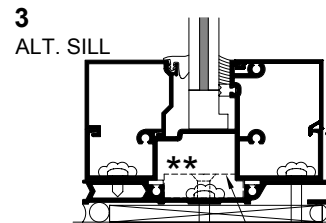
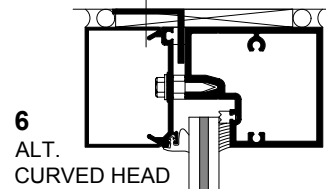

HIGH PERFORMANCE SILL

** Use door jamb anchor block at door jambs with sidelites.

STRAP ANCHOR

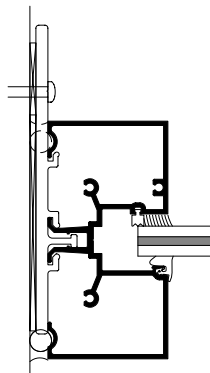

4 ALT. JAMB

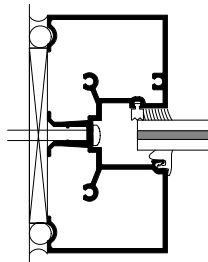

4 JAMB (Field glaze only)

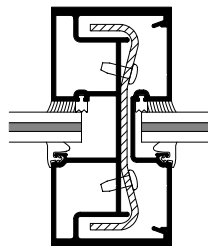

5 VERTICAL MULLION

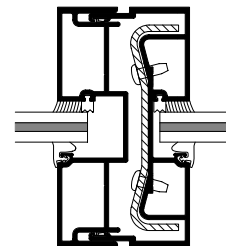

5 EXPANSION MULLION

Laws and building and safety codes governing the design and use of glazed entrance, window, and curtain wall products vary widely. Kawneer does not control the selection of product configurations, operating hardware, or glazing materials, and assumes no responsibility therefor.

Kawneer reserves the right to change configuration without prior notice when deemed necessary for product improvement.
© Kawneer Company, Inc. 2013

SCALE: 3" = 1'-0"

The Screw Spline method of fabrication and erection permits pre-assembly of single units in the shop or at the job site. These units are then erected by mating the male mullion half of one unit with the female mullion half of a unit already installed.

Note: 5/8" infill shown, 1/4" and 9/16" infill similar.

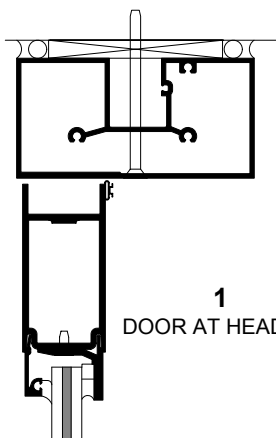
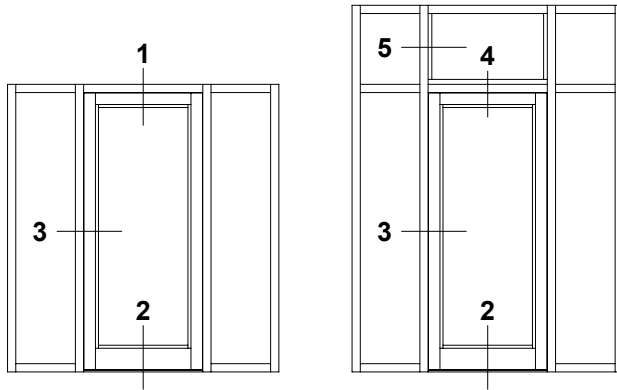

1 DOOR AT HEADER

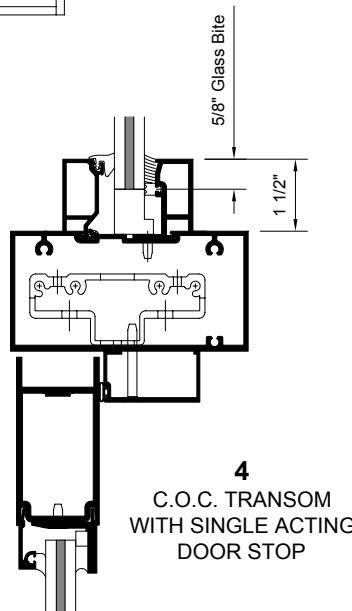

4 C.O.C. TRANSOM WITH SINGLE ACTING DOOR STOP

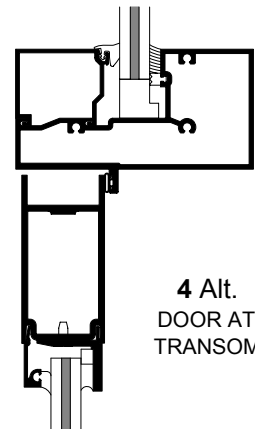

4 Alt. DOOR AT TRANSOM

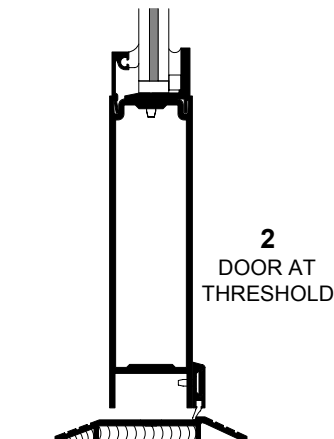

2 DOOR AT THRESHOLD

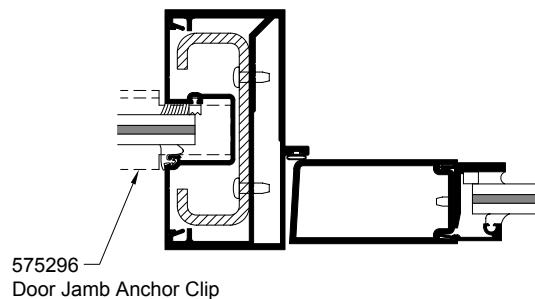

3 DOOR AT JAMB

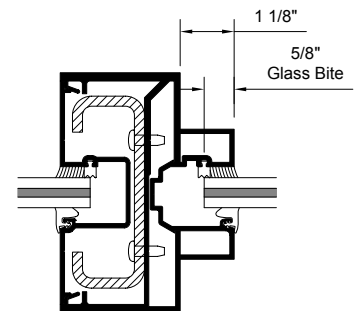

5 VERTICAL TRANSOM ABOVE DOOR

Laws and building and safety codes governing the design and use of glazed entrance, window, and curtain wall products vary widely. Kawneer does not control the selection of product configurations, operating hardware, or glazing materials, and assumes no responsibility therefor.

Kawneer reserves the right to change configuration without prior notice when deemed necessary for product improvement.

© Kawneer Company, Inc. 2013

SCALE: 3" = 1'-0"

The Screw Spline method of fabrication and erection permits pre-assembly of single units in the shop or at the job site. These units are then erected by mating the male mullion half of one unit with the female mullion half of a unit already installed.

Note: 1-5/16" infill shown.

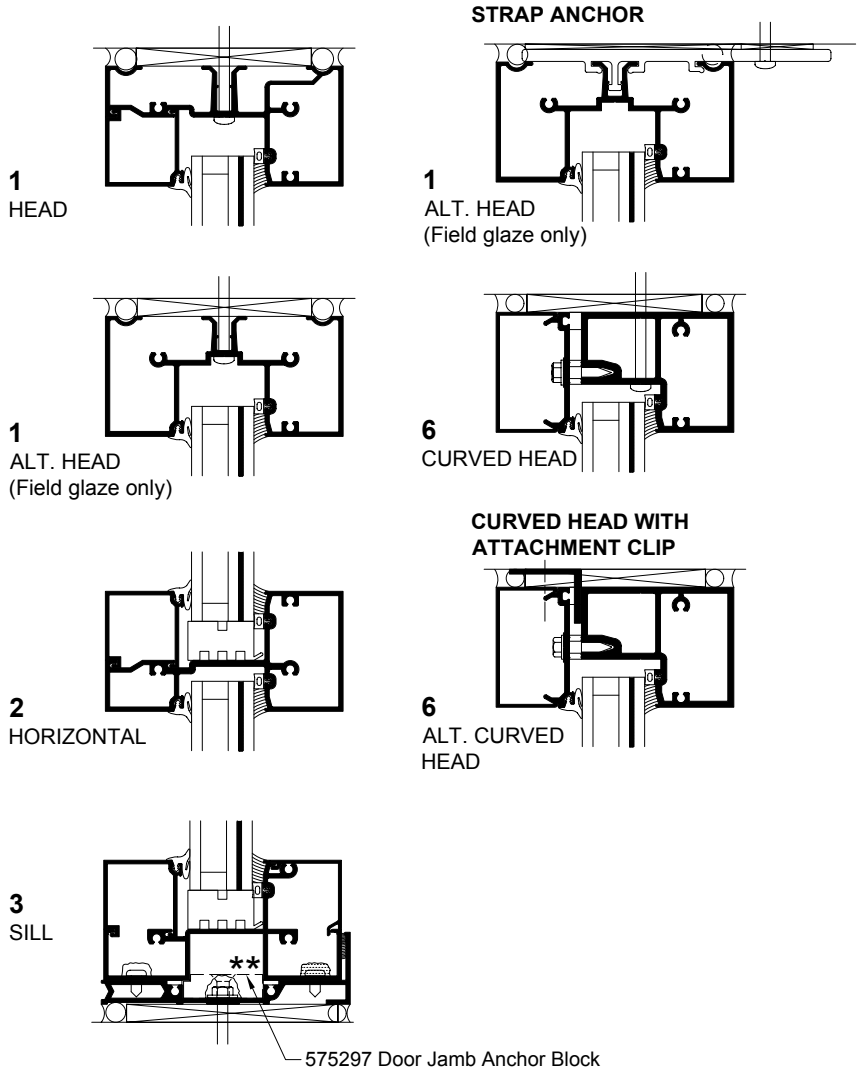
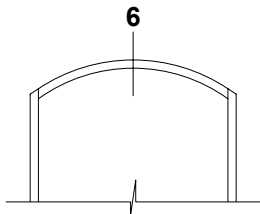
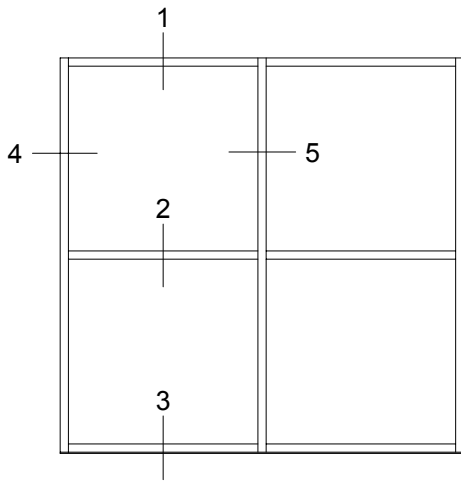

HIGH PERFORMANCE SILL

** Use door jamb anchor block at door jambs with sidelites.

STRAP ANCHOR

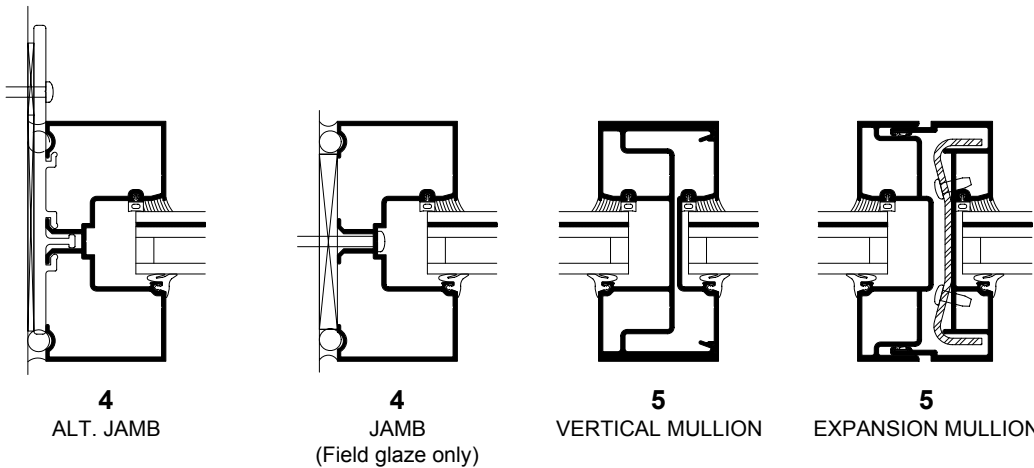

Laws and building and safety codes governing the design and use of glazed entrance, window, and curtain wall products vary widely. Kawneer does not control the selection of product configurations, operating hardware, or glazing materials, and assumes no responsibility therefor.

Kawneer reserves the right to change configuration without prior notice when deemed necessary for product improvement.
© Kawneer Company, Inc. 2013

SCALE: 3" = 1'-0"

The Screw Spline method of fabrication and erection permits pre-assembly of single units in the shop or at the job site. These units are then erected by mating the male mullion half of one unit with the female mullion half of a unit already installed.

Note: 1-5/16" infill shown.

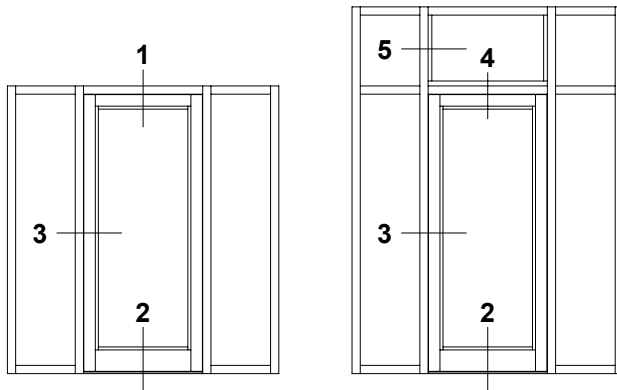

#12 x 2" F.H. screw at 3" from each end and 11" on center typical

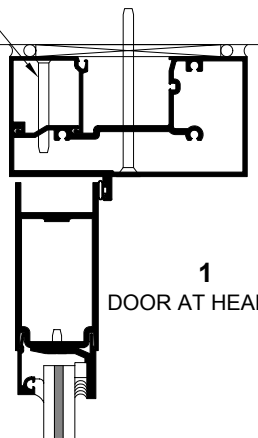

1
DOOR AT HEADER

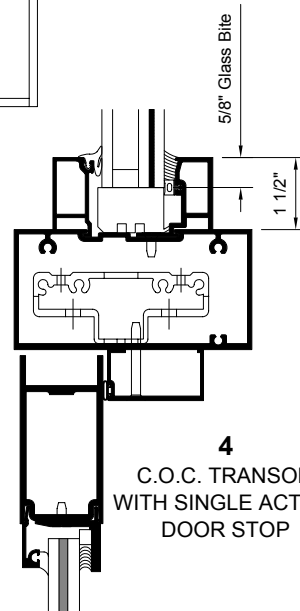

4
C.O.C. TRANSOM
WITH SINGLE ACTING
DOOR STOP

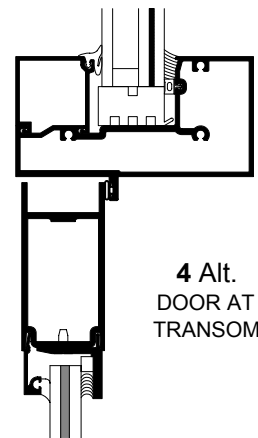

4 Alt.
DOOR AT
TRANSOM

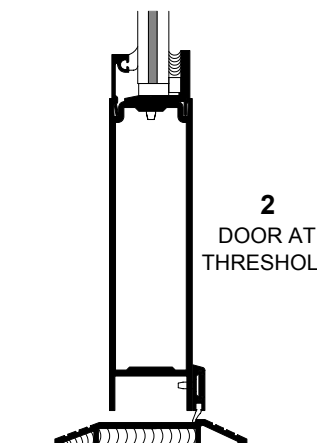

2
DOOR AT
THRESHOLD

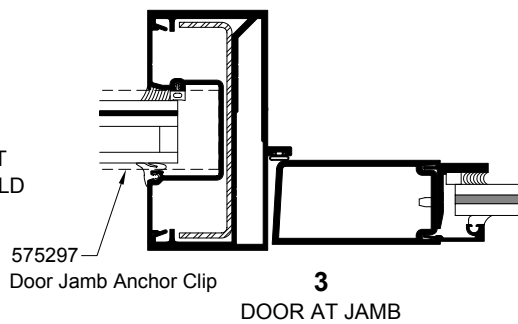

3
DOOR AT JAMB

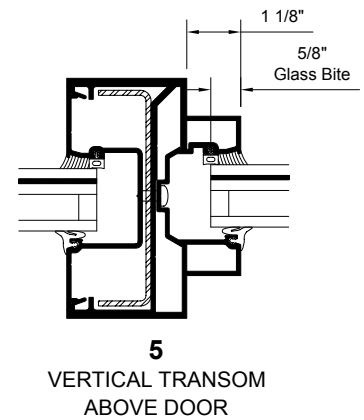

5
VERTICAL TRANSOM
ABOVE DOOR

Laws and building and safety codes governing the design and use of glazed entrance, window, and curtain wall products vary widely. Kawneer does not control the selection of product configurations, operating hardware, or glazing materials, and assumes no responsibility therefor.

Kawneer reserves the right to change configuration without prior notice when deemed necessary for product improvement.

© Kawneer Company, Inc. 2013

FABRICATION (IR 501)

Measure the opening to determine the required length of vertical and horizontal framing members. Allow a minimum of 1/4" clearance at the head, sill and both jambs to facilitate installation and provide space for caulking. If job conditions are uncertain or masonry openings are irregular, allow extra clearance to accommodate construction tolerances.

Cut vertical members to required length (frame height). At required horizontal locations using drill jigs, drill fastener holes in the verticals as shown below. Cut horizontal members to required length (DLO). Cut glass stops to required length (DLO + 0", - 1/16").

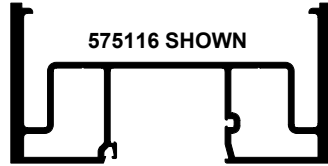

SCREW SPLINE PREPS TO VERTICAL MEMBERS

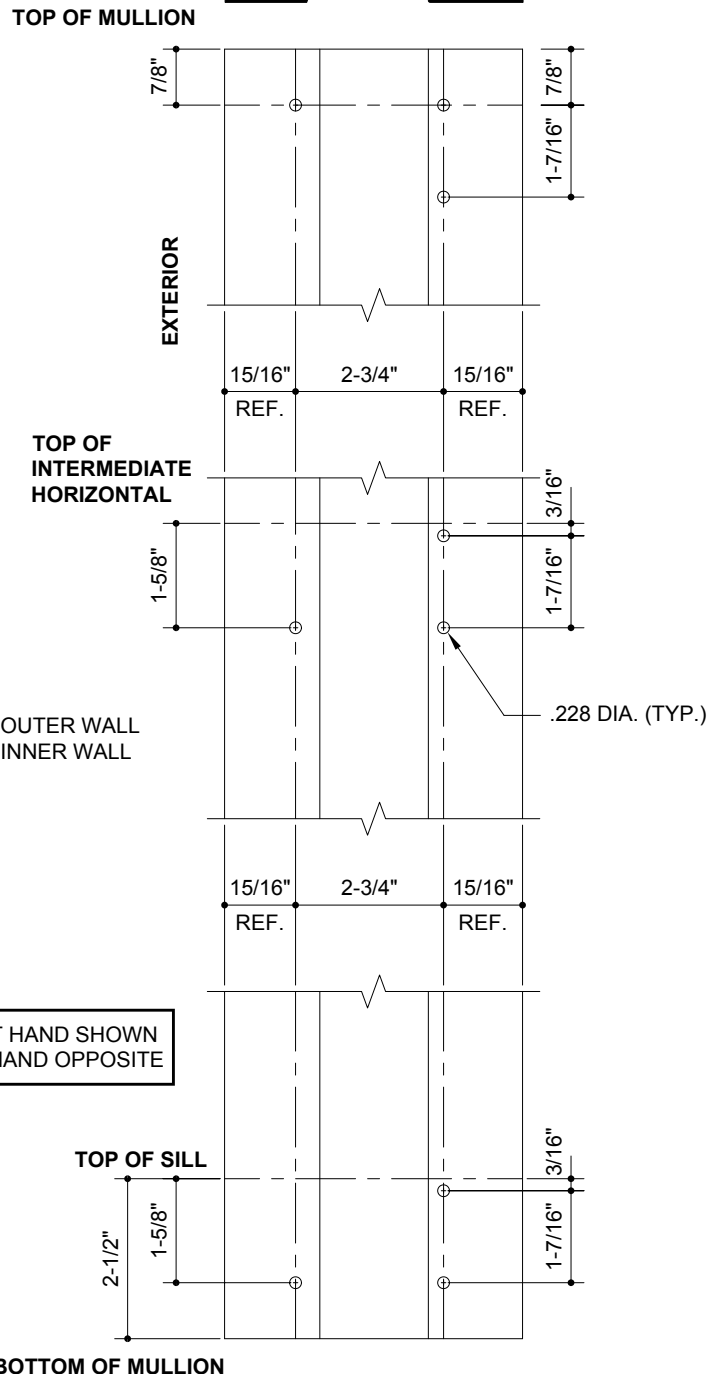
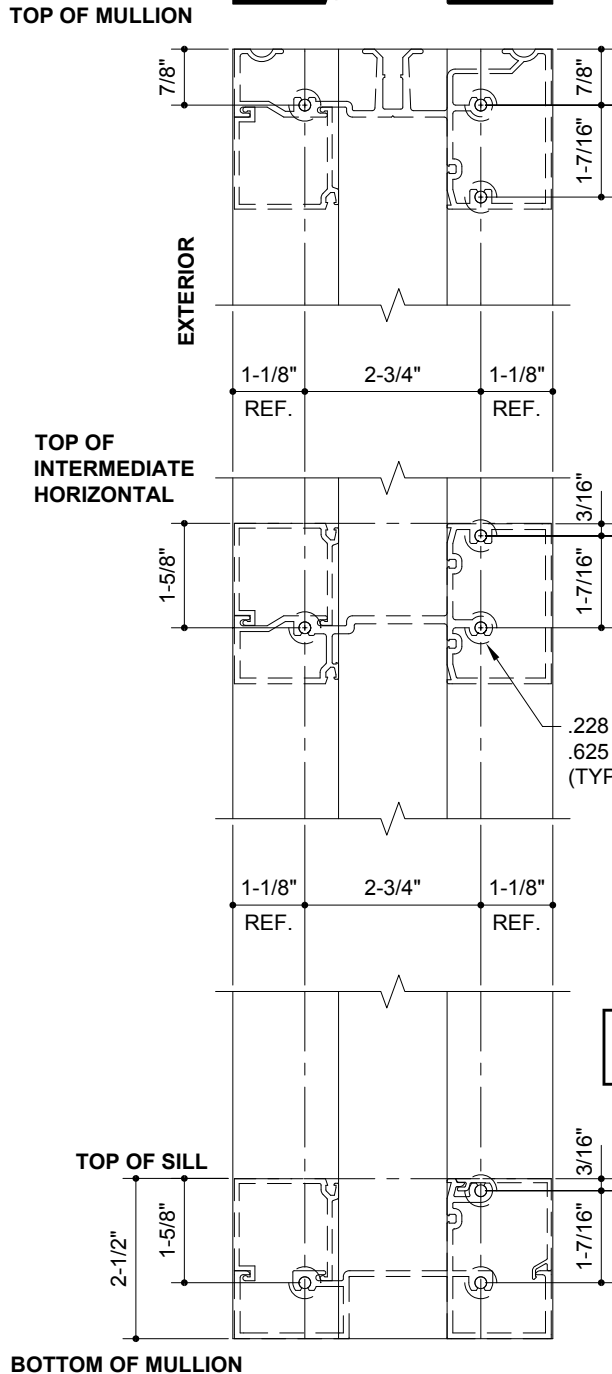
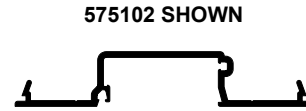

RIGHT HAND SHOWN
LEFT HAND OPPOSITE

Laws and building and safety codes governing the design and use of glazed entrance, window, and curtain wall products vary widely. Kawneer does not control the selection of product configurations, operating hardware, or glazing materials, and assumes no responsibility therefor.

Kawneer reserves the right to change configuration without prior notice when deemed necessary for product improvement.

© Kawneer Company, Inc. 2013

ASSEMBLY (Typical)

WET GLAZED:

Spacer cannot be installed after the frames are assembled. Spacer must be installed prior to frame assembly. Slide the required silicone spacer into all interior reglets in both the horizontal and vertical members.

Apply sealant to the ends of all horizontal members to provide a good seal at the vertical members. Vertical mullions always run through, and horizontal mullions butt between the vertical mullions.

Assemble the units using three (3) 128267 (#12 x 1" pan head) screws at each joint as shown below. Make sure each unit includes a male and female vertical mullion half, with a deep pocket in at least one of the verticals.

Assembled frames may be pre glazed in the shop, or in the field. If the frames are pre glazed in the shop, the end lites must be field glazed so that the jambs can be anchored to the perimeter condition through the glass pocket, or anchored with 575036 strap anchors.

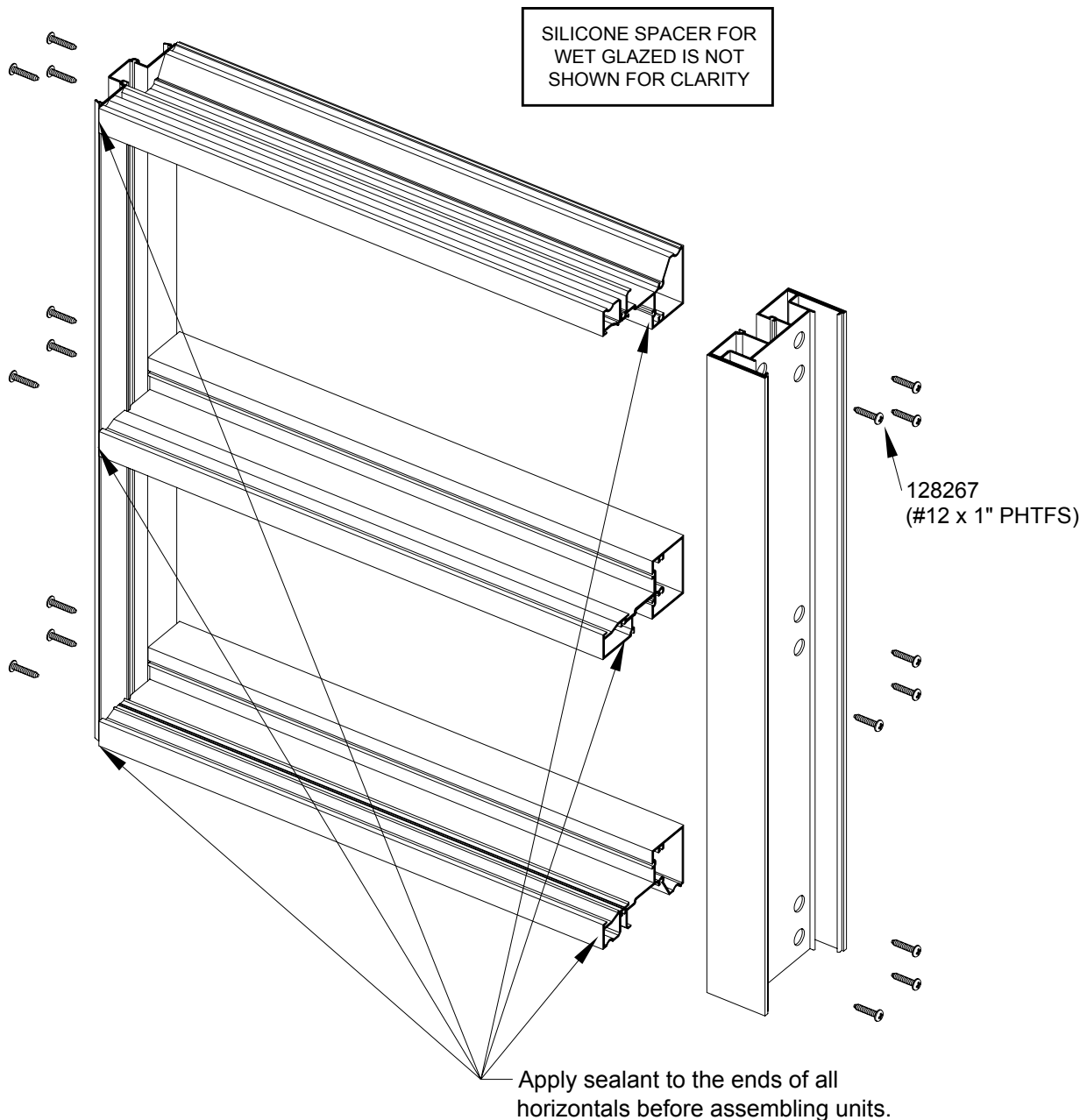

Laws and building and safety codes governing the design and use of glazed entrance, window, and curtain wall products vary widely. Kawneer does not control the selection of product configurations, operating hardware, or glazing materials, and assumes no responsibility therefor.

Kawneer reserves the right to change configuration without prior notice when deemed necessary for product improvement.
© Kawneer Company, Inc. 2013

ASSEMBLY (Curved Head)

Laws and building and safety codes governing the design and use of glazed entrance, window, and curtain wall products vary widely. Kawneer does not control the selection of product configurations, operating hardware, or glazing materials, and assumes no responsibility therefor.

Kawneer reserves the right to change configuration without prior notice when deemed necessary for product improvement.

© Kawneer Company, Inc. 2013

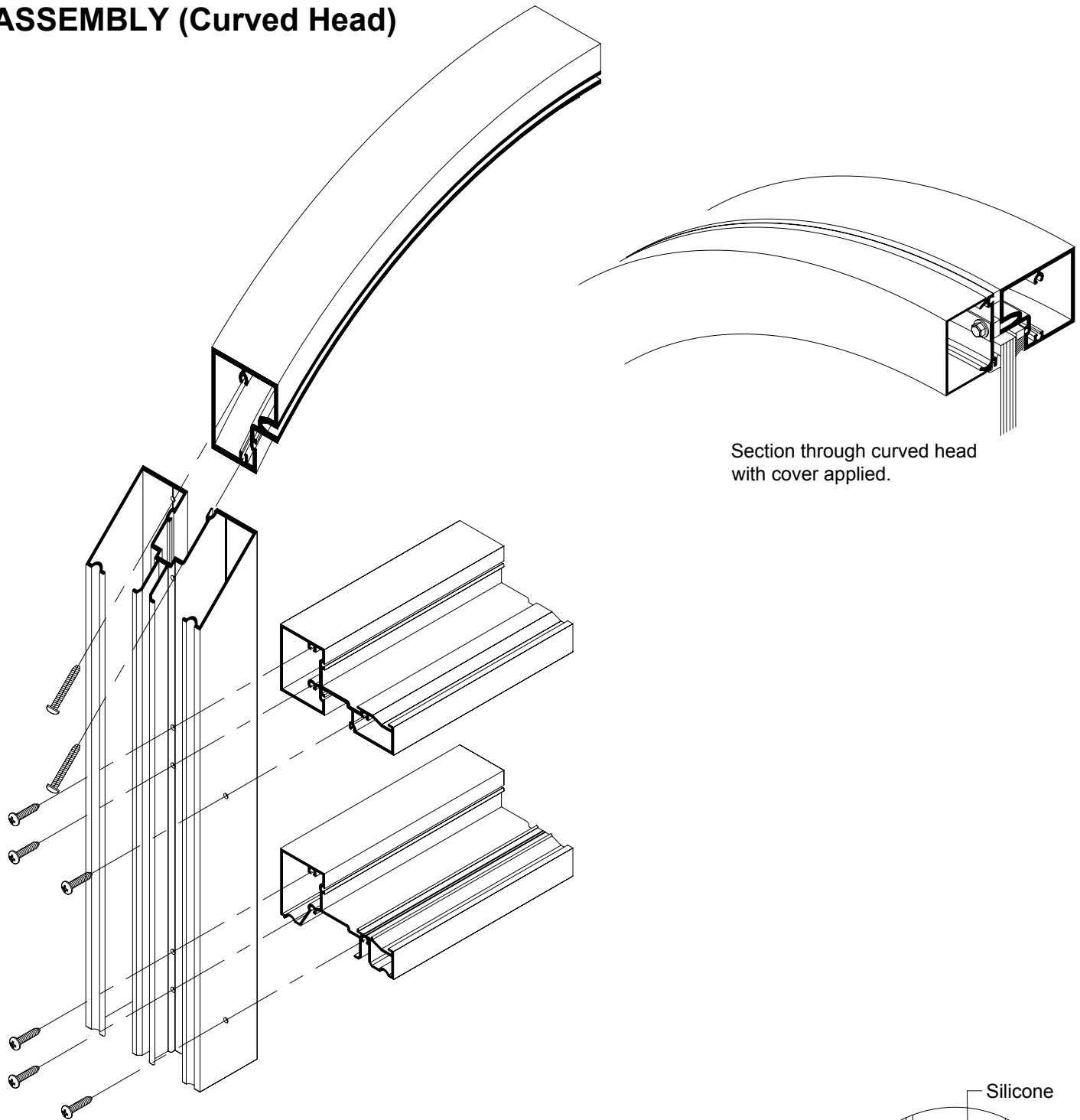

Section through curved head with cover applied.

Note: The 575029 glazing adapter is designed to be slid into the spacer reglet prior to assembly of the frame. **The adapter cannot be snapped into the frame after assembly.** Vertical adapters run through. Note that the adapter will not fit into the 575002 pocket filler and the 575009 male expansion mullion half. There is a special pocket filler, 575044 (shallow) or 575046 (deep) and 575008 male expansion mullion half for single glazing.

Vertical adaptors run through and should be cut to the same length as jamb or vertical mullion to which they will be inserted, horizontal adaptors should be cut to DLO and/or same length as the horizontal member to which they will be inserted.

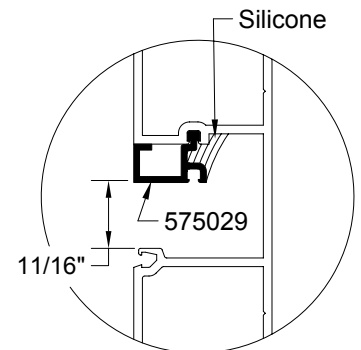

INSTALLATION (IR 500)

Attach 575114 end dam at perimeter ends of flashing. Apply sealant to end dam as shown below and clamp in place. Carefully tool excess sealant and allow the sealant to cure. Install 575037 flashing at the sill and attach it to the floor. The flashing should be shimmed up a minimum of 1/4" to make sure that it is flat and level. The flashing should also run the full width of the opening - 1/4", and be interrupted only at entrances. If the opening is over 24'-0" wide a splice joint is required every 12'-0" (see splice joint procedure below).

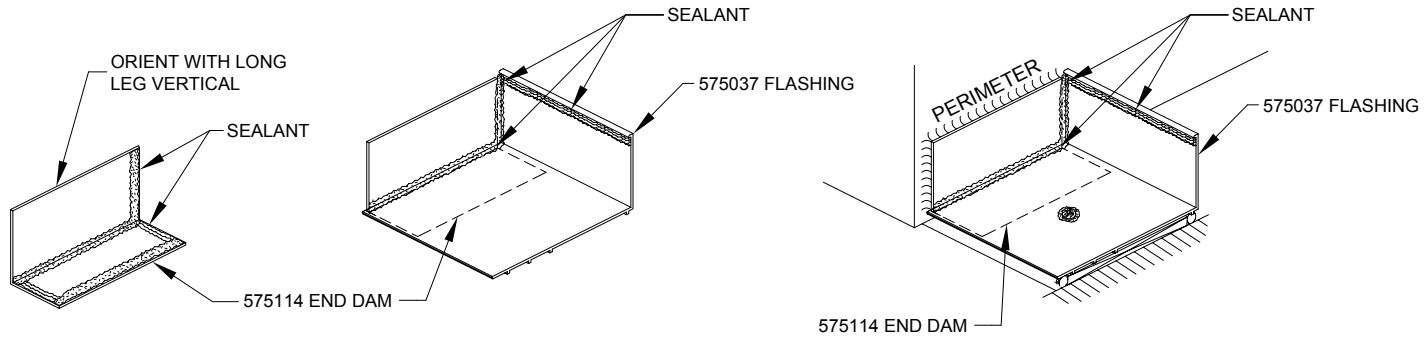

SPLICE JOINTS

SPLICES SHOULD BE LOCATED A MAXIMUM OF EVERY 12'-0" WITH A 1/2" JOINT BETWEEN HEAD & SILL MEMBERS. DO NOT LOCATE SPLICE DIRECTLY UNDER A VERTICAL MULLION.

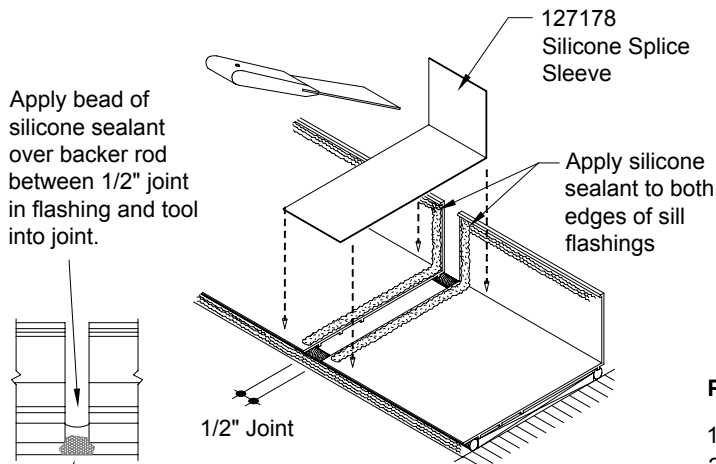

FIGURE 1

Apply bead of silicone sealant over backer rod between 1/2" joint in flashing and tool into joint.

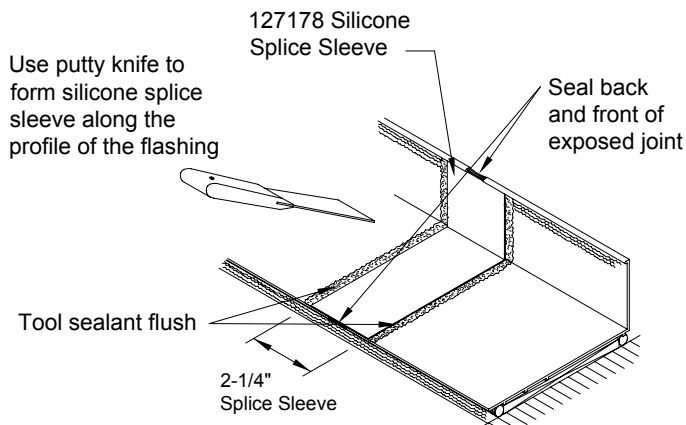

FIGURE 2

NOTE:

1) SPLICES SHOULD BE INSTALLED EVERY 12' WHEN FLASHING IS OVER 24'. SPLICE SLEEVES ARE TO BE LOCATED AT THE CENTER OF A DLO.

DO NOT LOCATE SPLICE SLEEVES AT MULLIONS.

2) IF THERE IS AN ENTRANCE, THE ENTRANCE FRAME AND ATTACHED SIDELITE(S) SHOULD BE INSTALLED FIRST, BEING CAREFUL TO LOCATE THEM ACCURATELY IN THE OPENING. FASTEN THE ENTRANCE FRAME TO THE PERIMETER CONDITION AS NECESSARY USING THE REQUIRED PERIMETER FASTENERS.

3) SILICONE MUST BE TESTED AND APPROVED FOR COMPATIBILITY BY THE SEALANT MANUFACTURER.

PROCEDURE FOR INSTALLING SILICONE SPLICE SLEEVE

1. Cut Silicone Splice Sleeve (127178) to required length.
2. Clean splice area with solvent.
3. Apply bead of silicone within 1/2" of the edge of the sill members on each side of the 1/2" joint. (Figure 1)
4. Remove protective liner from Splice Sleeve.
(For cold weather applications see note below.)
5. Center the Splice Sleeve over the joint. Then, using a putty knife, form the Splice Sleeve along the profile of the flashing. (Figure 2)
6. Silicone will squeeze out from under the Splice Sleeve. Use putty knife to tool off excess silicone. (Figure 2)
7. Seal back and front of exposed joint. Be sure to force sealant up under the Splice Sleeve in front. (Figure 2)

COLD WEATHER NOTE:

FOR TEMPERATURES BELOW 40° THE FOLLOWING PRECAUTIONS SHOULD BE TAKEN. JUST PRIOR TO INSTALLING THE SPLICE SLEEVE, WIPE SILL FLASHING WITH A SOLVENT OR CLEANING SOLUTION RECOMMENDED BY THE SEALANT MANUFACTURER.

CAUTION:

CAREFULLY FOLLOW THE RECOMMENDATIONS CONTAINED IN THE MATERIAL SAFETY DATA SHEET PROVIDED BY THE SOLVENT/CLEANING SOLUTION MANUFACTURER REGARDING HEALTH AND FIRE/EXPLOSION RISKS.

INSTALLATION (Continued)

Position the assembled frame in the opening to align it with the sill flashing, checking to make sure that the unit is level and plumb.

Insert shims as needed at the head and jambs, and anchor the frame to the perimeter condition as required for exterior, center or interior attachment. Shims should span to both return caulk legs on the head and jambs. Contact your Area Application Engineering Dept. for help in selecting fasteners if necessary. Seal over the heads of all fasteners at the sill.

Caulk the exterior perimeter joints at the head, jambs and under the sill flashing with a high quality sealant. Do not caulk between the sill member and the sill flashing. This area must be left open to allow water to drain.

NOTE: FORCE SEALANT INTO THE HOLES FOR SILL PERIMETER FASTENERS PRIOR TO INSERTING THE FASTENERS. THIS IS IMPORTANT TO INSURE THAT THE HOLES IN THE SILL FLASHING ARE SEALED BEFORE THE FASTENERS ARE INSTALLED.

Seal over fastener heads at sill.

EXTERIOR ATTACHMENT

Do not seal between sill and flashing. It must be left open for drainage.

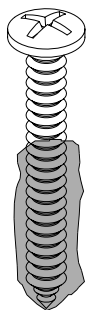
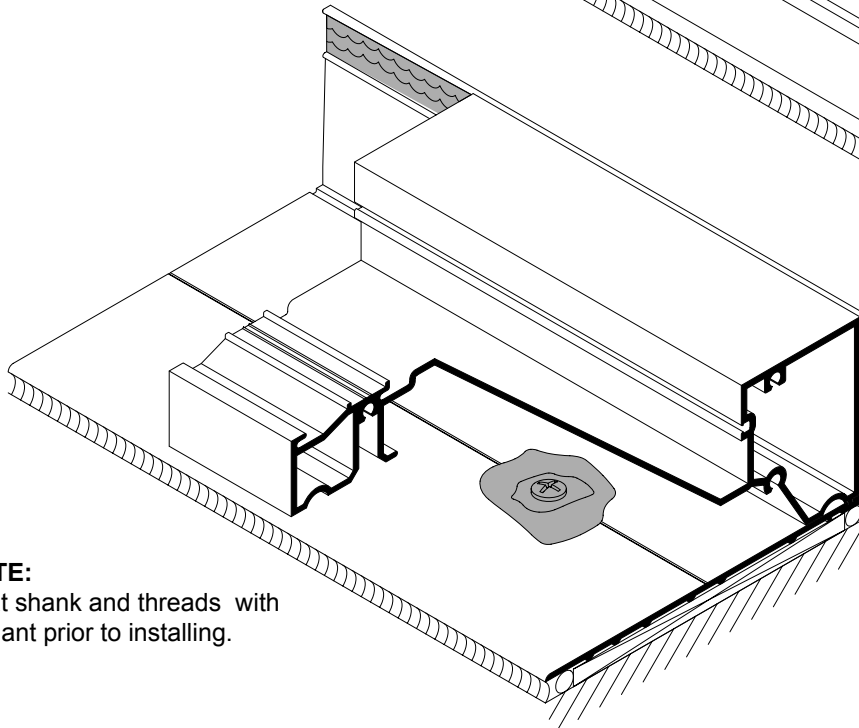
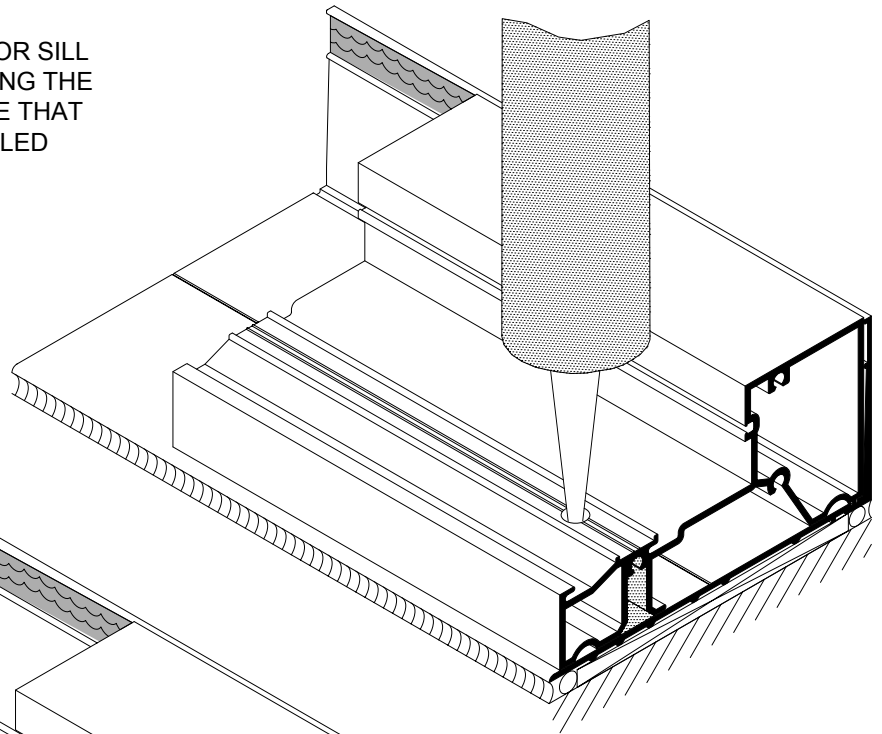
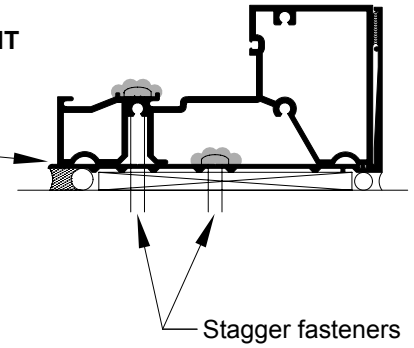

NOTE: Coat shank and threads with sealant prior to installing.

Laws and building and safety codes governing the design and use of glazed entrance, window, and curtain wall products vary widely. Kawneer does not control the selection of product configurations, operating hardware, or glazing materials, and assumes no responsibility therefor.

Kawneer reserves the right to change configuration without prior notice when deemed necessary for product improvement.

© Kawneer Company, Inc. 2013

INSTALLATION (IR 501)

Ensure the end dam aligns with the back edge of the flashing and holes align with the screw splines on the HP sill flashing. Holes on the right side of the end dam & flashing are opposite of the left side.

The flashing must be carefully sealed at each end, filling hollows with sealant. Apply sealant to end dam as shown at right.

Attach 575208 end dam at perimeter ends of flashing with (2) 128271 fasteners. Carefully tool excess sealant and allow sealant to cure. Install 575157 flashing at the sill and attach it to the floor. The flashing should be shimmed up a minimum of 1/4" to make sure that it is flat and level. The flashing should also run the full width of the opening - 1/4", and be interrupted only at entrances.

Note:

If the opening is over 24'-0" wide a splice joint is required every 12'-0", with a 1/2" joint between head and sill members at the center of the DLO. Do not locate splice directly under a vertical mullion.

Apply bond breaker tape to the underside of the aluminum splice sleeve as show on center.

Clean splice area with solvent.

Note: For temperatures below 40°, take the following precautions. Just prior to installing the sleeve, wipe flashing material with a solvent or cleaning solution recommended by the sealant manufacture. This will remove any condensation or frost that may be present. Carefully follow the recommendations contained in the material.

Caution: safety data sheet provided by the solvent / cleaning solution manufacturer regarding health and fire / explosion risks.

Apply heavy bead of silicone sealant on one receptor and bead of non-skinning, non-hardening sealant on the other receptor. Install splice sleeve so that bond breaker tape aligns with splice joint as shown.

Pin splice sleeve on the side with the silicone joint and seal over heads of pins. Apply a secondary silicone seal on the pinned side as shown.

Apply bond breaker tape over the joint between the splice and receptor on the bead of non-skinning, non hardening sealant side of splice.

Apply silicone sealant over the bond breaker tape to create a water tight joint as shown.

Seal exposed joint at the back of the sill flashing, and force sealant up under the splice sleeve in the front.

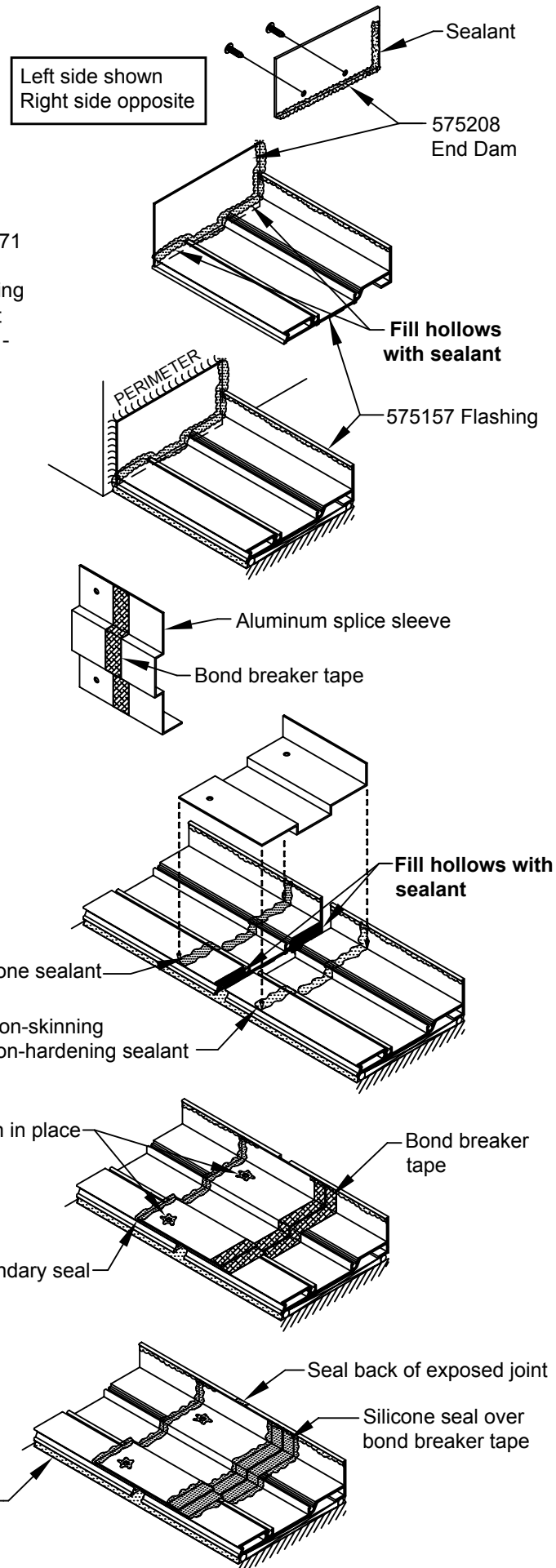

INSTALLATION (Continued)

NOTE: FORCE SEALANT INTO THE HOLES FOR SILL PERIMETER FASTENERS PRIOR TO INSERTING THE FASTENERS. THIS IS IMPORTANT TO INSURE THAT THE HOLES IN THE SILL FLASHING ARE SEALED BEFORE THE FASTENERS ARE INSTALLED.

Seal over fastener heads at sill.

Attach 127120 tape along the full length of sill flashing at two locations as shown before sitting frames onto flashing.

Weep Holes 5/16" Dia. Hole (2) Per Glass Lite

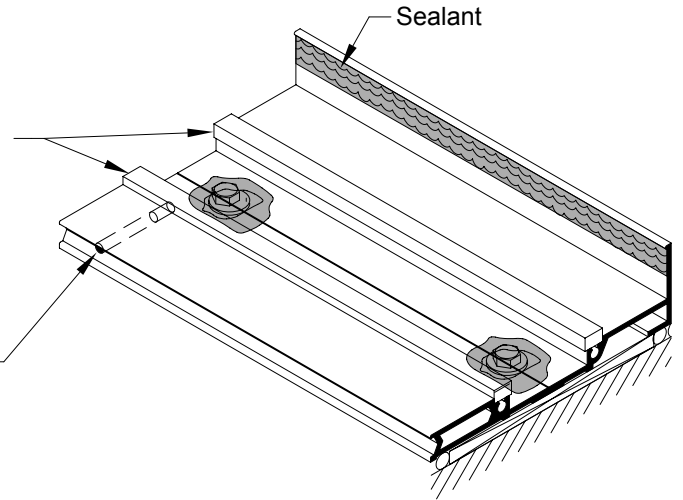

Install the frame units starting at the entrance and working towards the other end. If there is no entrance, start at one jamb and then work toward the other jamb. **NOTE THAT IF 575036 STRAP ANCHORS ARE USED AT THE JAMB, THEY MUST BE SLID ONTO THE JAMBS BEFORE INSTALLATION OF THE END UNITS.** Crimp one of the retaining legs at the bottom of the jambs to prevent them from sliding off the jambs during installation. Slide them up to the required locations after the frame is set in place.

The first unit should be attached to the perimeter condition as required at the head, sill and jamb. The remaining units are installed by snapping together the female mullion half with the male mullion half of the adjacent unit as shown below. Apply sealant to the ends of the horizontal mullions, and silicone to the snap legs on the male mullion half, prior to snapping the units together.

NOTE: Apply silicone to the snap legs on the male mullion half to insure a positive connection to resist cycling pressures.

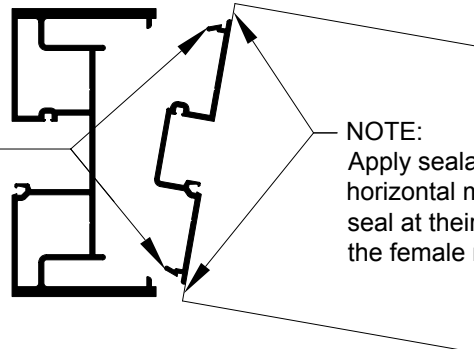

NOTE: Apply sealant to the ends of the horizontal mullions to assure a seal at their point of contact with the female mullion half.

NOTE: Mullions are not designed to be unsnapped after installation.

The last unit should be pivoted into position using the last installed mullion half as a pivot point. With narrow units (under 4') the last two units should be snapped together and installed as a single unit.

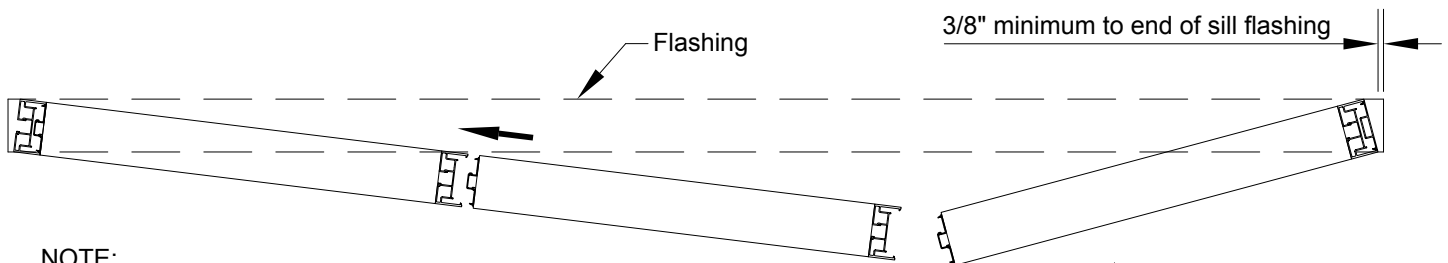

NOTE: By snapping the mullion halves together as the frame is assembled, the frame can be installed as one unit for elevations less than three bays wide.

Rotate last panel into position.

Laws and building and safety codes governing the design and use of glazed entrance, window, and curtain wall products vary widely. Kawneer does not control the selection of product configurations, operating hardware, or glazing materials, and assumes no responsibility therefor.

Kawneer reserves the right to change configuration without prior notice when deemed necessary for product improvement.
© Kawneer Company, Inc. 2013

INSTALLATION (Continued)

At "V" groove drill 5/16" dia. weep hole through sill and first wall (ONLY) of flashing, at centerline of each horizontal.

Position the assembled frame in the opening to align it with the sill flashing, checking to make sure that the unit is level and plumb.

Insert shims as needed at the head and jambs, and anchor the frame to the perimeter condition as required for exterior, center or interior attachment. Shims should span to both return caulk legs on the head and jambs. Contact your Area Application Engineering Dept. for help in selecting fasteners if necessary. Seal over the heads of all fasteners at the sill.

Caulk the exterior and interior perimeter joints at the head, jambs and under the sill flashing with a high quality sealant.

At "V" groove drill 5/16" dia. weep hole in sill and first wall of flashing, at centerline of horizontals

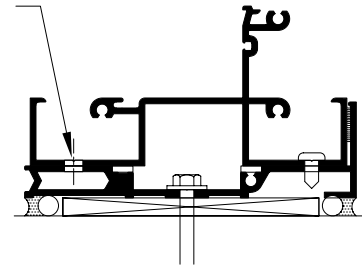

SHIM INSTALLATION

Install support shims at head, sill and jamb. Place between pocket filler and perimeter condition at perimeter anchor locations.

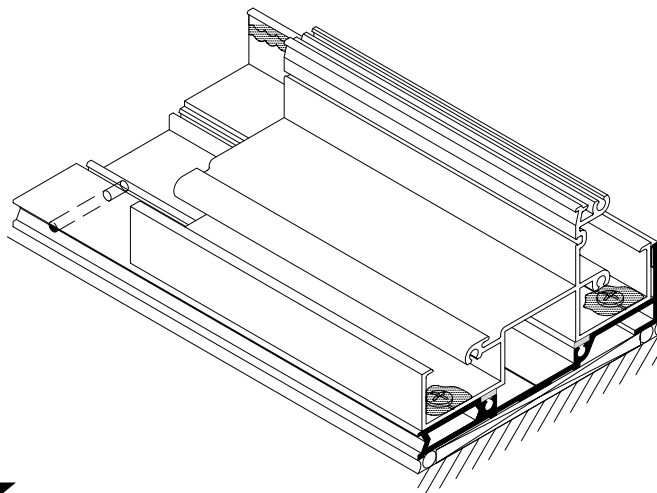
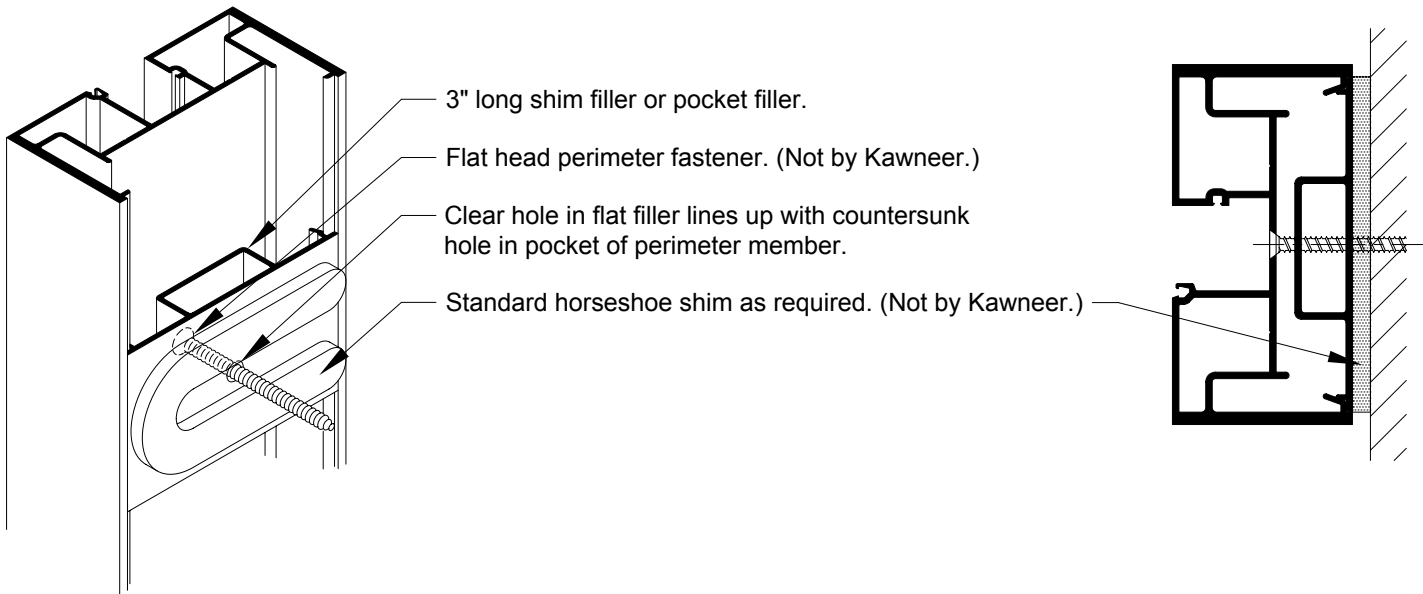

EXTERIOR ATTACHMENT

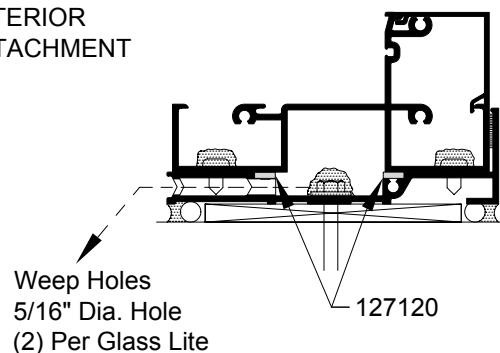

Laws and building and safety codes governing the design and use of glazed entrance, window, and curtain wall products vary widely. Kawneer does not control the selection of product configurations, operating hardware, or glazing materials, and assumes no responsibility therefor.

Kawneer reserves the right to change configuration without prior notice when deemed necessary for product improvement.
© Kawneer Company, Inc. 2013

INSTALLATION (Continued)

Install water deflectors on intermediate horizontals as shown. Use water deflector 175313 for IR 500, and 451105 for IR 501. Remove the paper backing from the water deflectors and install them on a clean, dry surface centered in the glazing pockets of the intermediate horizontals.

Wet glazed: Note that the silicone spacer must be cut short or notched at the top of all intermediate horizontal pockets to allow installation of the water deflectors.

COLD WEATHER NOTE:

For temperatures below 40° the following precautions should be taken: Just prior to installing the water deflectors, wipe glazing pocket with a solvent or cleaning solution recommended by the manufacturer.

***CAUTION:** Carefully follow the recommendations contained in the material data safety sheet provided by the solvent/cleaning solution manufacturer regarding health and fire/explosion risks.

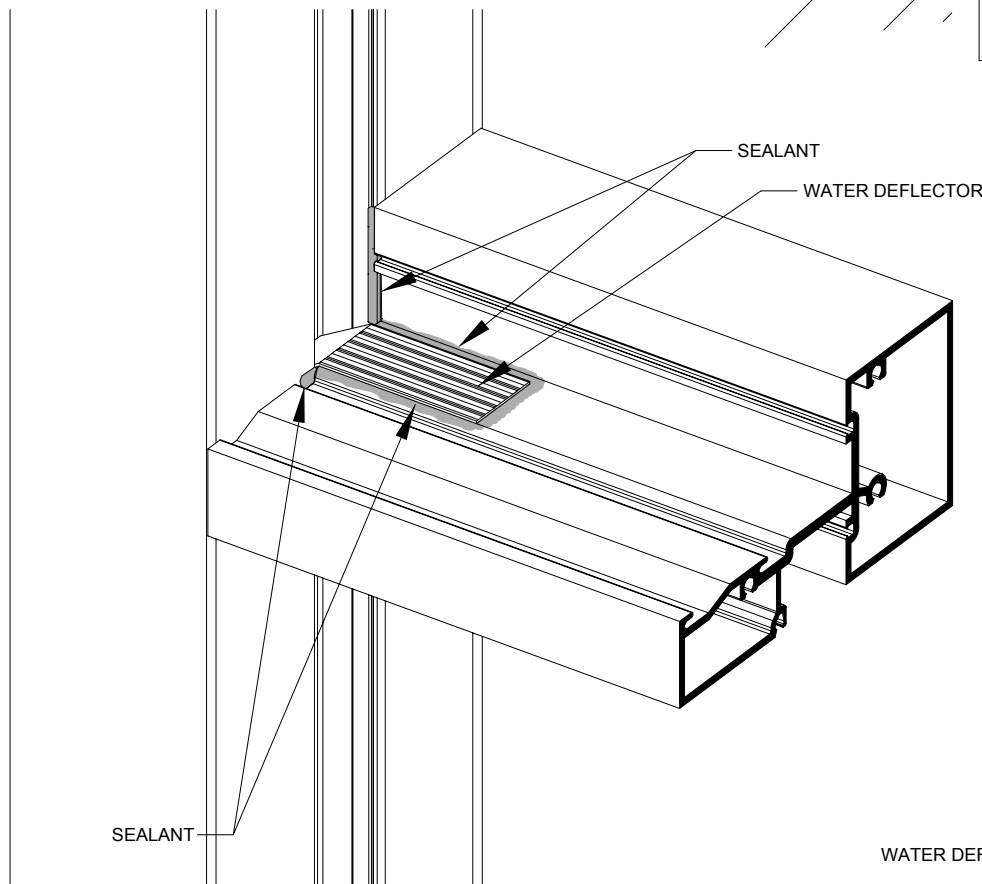
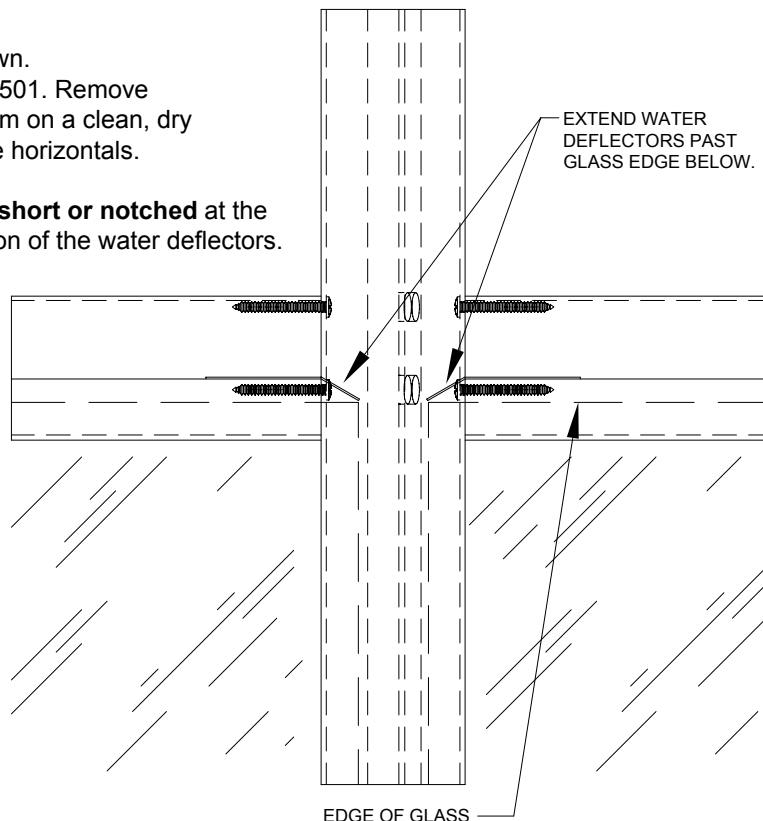

SILICONE SPACER FOR WET GLAZED IS NOT SHOWN FOR CLARITY

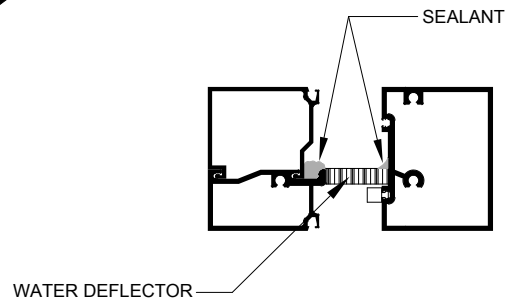

AFTER THE WATER DEFLECTOR IS INSTALLED, SEAL THE JOINT BETWEEN THE BACK OF THE HORIZONTAL AND THE VERTICAL. MAKE SURE TO SEAL THE JOINT BETWEEN ANY GLAZING ADAPTERS AND ANY VOID IN THE GLAZING REGLETS IN THIS AREA TO PREVENT WATER FROM RUNNING DOWN TO THE LITE BELOW.

Laws and building and safety codes governing the design and use of glazed entrance, window, and curtain wall products vary widely. Kawneer does not control the selection of product configurations, operating hardware, or glazing materials, and assumes no responsibility therefor.

Kawneer reserves the right to change configuration without prior notice when deemed necessary for product improvement.
© Kawneer Company, Inc. 2013

The standard glass pocket is approximately 1-1/16" in width, and the glass pocket with adapter is approximately 11/16" in width. These pockets are designed for glass products that are typically used in applications that must conform to hurricane impact/cycling requirements. **Contact your Kawneer representative for specific glazing applications.**

Typical glass size is daylight opening (DLO) + 1-1/4" (Except at transom area with applied stops, see page 11).

NOTE: This formula does not allow for undersized or out of square daylight openings.

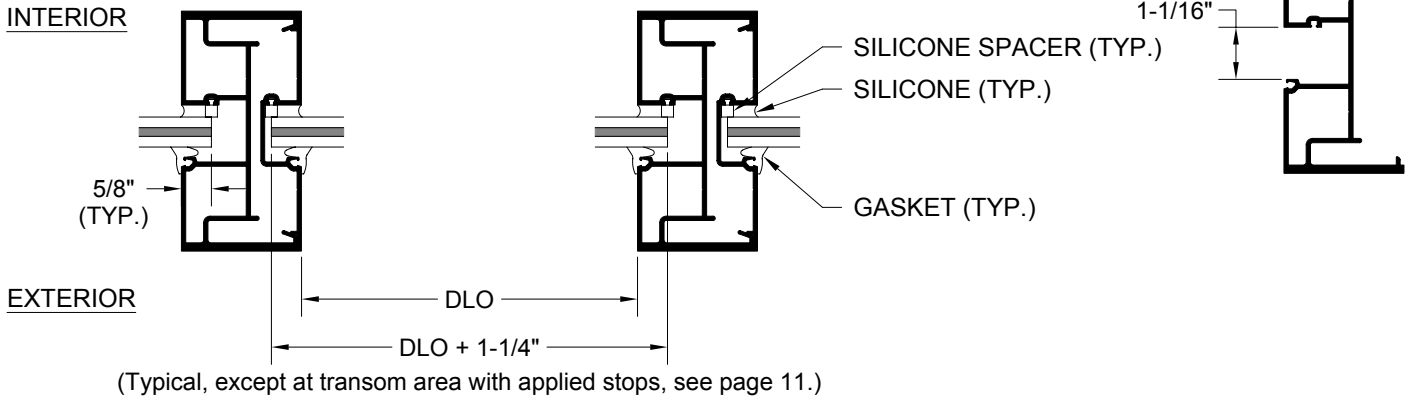

Glazing Chart for IR 500 Framing					
Nominal Infill Thickness	Actual Infill Thickness	Adapter	Exterior Gasket	Interior Spacer / Interior Gasket	Impact Rating
1/4" Wet Glaze*	0.191" - 0.253"	575029	027077	127011	N/A
9/16" Wet Glaze	0.555" - 0.617"	-	027074	127012	Large
5/8" Wet Glaze	0.591" - 0.653"	-	027077	127011	Large
9/16" Dry Glaze	0.555" - 0.617"	-	127147	127146	Large

Exterior Glazing Gaskets



027074 (Standard)
WET

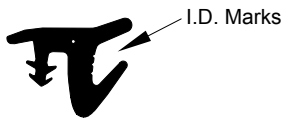

027077 (Heavy)
WET

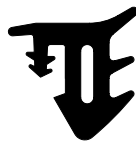

127147
DRY

NOTE: I.D. Marks = 3 for Heavy and none for Standard

Interior Spacer



127011
WET



127012
WET

Interior Gasket



127146
DRY

***NOTE:**

Nominal infill thickness is 1/4"

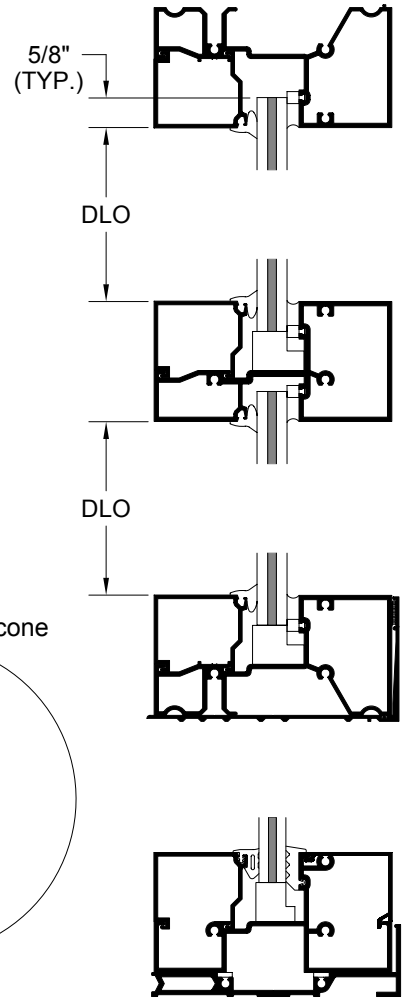
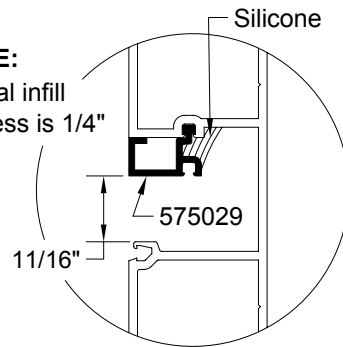

Position the glass in the frame using the standard flush glazing technique. Place setting blocks under the glass at 1/4 points or as otherwise specified by engineering calculations. Make sure that there is a consistent glass bite of 5/8" on each side on each side of the glass.

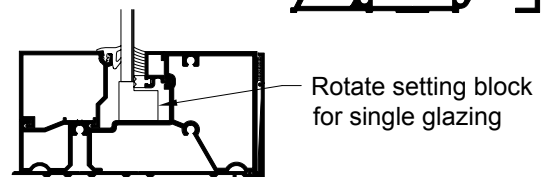

Laws and building and safety codes governing the design and use of glazed entrance, window, and curtain wall products vary widely. Kawneer does not control the selection of product configurations, operating hardware, or glazing materials, and assumes no responsibility therefor.

Kawneer reserves the right to change configuration without prior notice when deemed necessary for product improvement.
© Kawneer Company, Inc. 2013

The standard glass pocket is approximately 1-11/16" in width, and the glass pocket with adapter is approximately 1-5/16" in width. These pockets are designed for some of the glass products that are typically used in applications that must conform to hurricane impact/cycling requirements. CONTACT YOUR KAWNEER REPRESENTATIVE FOR SPECIFIC GLAZING RECOMMENDATIONS FOR SPECIFIC APPLICATIONS.

Typical glass size is daylight opening (DLO) + 1-1/4" (Except at transom area with applied stops, see page 13).

NOTE: This formula does not allow for undersized or out of square daylight openings.

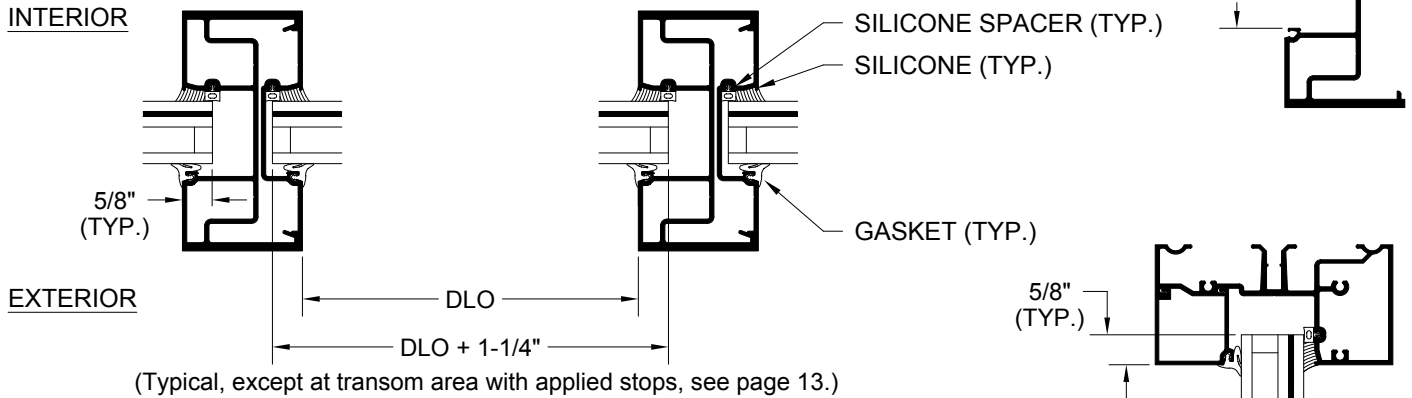

Glazing Chart for IR 501 Framing					
Nominal Infill Thickness	Actual Infill Thickness	Adapter	Exterior Glazing Gasket	Interior Spacer / Interior Gasket	Impact Rating
1" Dry Glaze*	0.935" - 0.967"	451VG030	027074	027900	N/A
1-5/16" Wet Glaze	1.263" - 1.325"	-	027074	127191	Large
1-5/16" Dry Glaze	1.263" - 1.325"	-	127127	127121	Small & Large

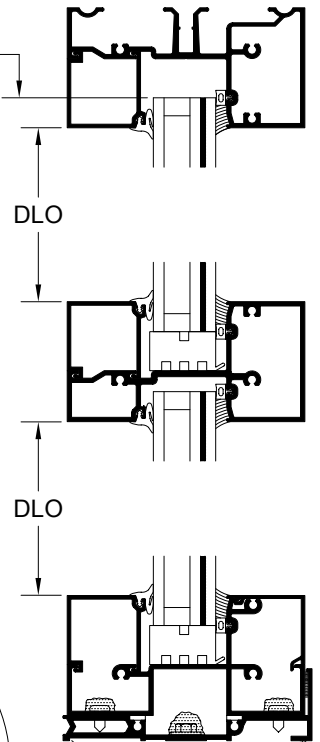
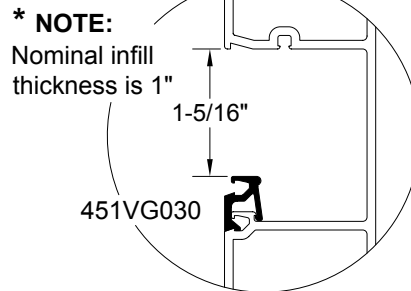
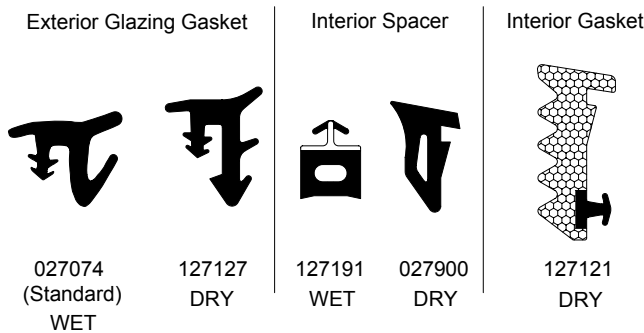

Position the glass in the frame using the standard flush glazing technique. Place setting blocks under the glass at 1/4 points or as otherwise specified by engineering calculations. Make sure that there is a consistent glass bite of 5/8" on each side on each side of the glass.

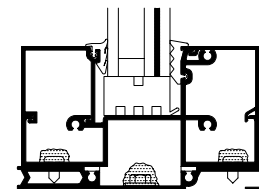

Laws and building and safety codes governing the design and use of glazed entrance, window, and curtain wall products vary widely. Kawneer does not control the selection of product configurations, operating hardware, or glazing materials, and assumes no responsibility therefor.

Kawneer reserves the right to change configuration without prior notice when deemed necessary for product improvement.

© Kawneer Company, Inc. 2013

"W" SIDE BLOCKS (Dry Glazing)

One "W" Side Block should be installed into the deep pocket of the mullion of each lite of glass in the opening.

"W" Block will expand and wedge between walls of glazing pocket pocket and prevent glass from shifting into deep pocket.

Note: If deglazing of the lite is required after "W" Block is installed, remove both interior and exterior weathering and use hook to pull "W" Block out of the pocket.

Side Block Installation

USE PART NO. 027908 FOR (IR 500)

USE PART NO. 422434 FOR (IR 501)

Flatten block and slide
slide between reglet
and glass lite

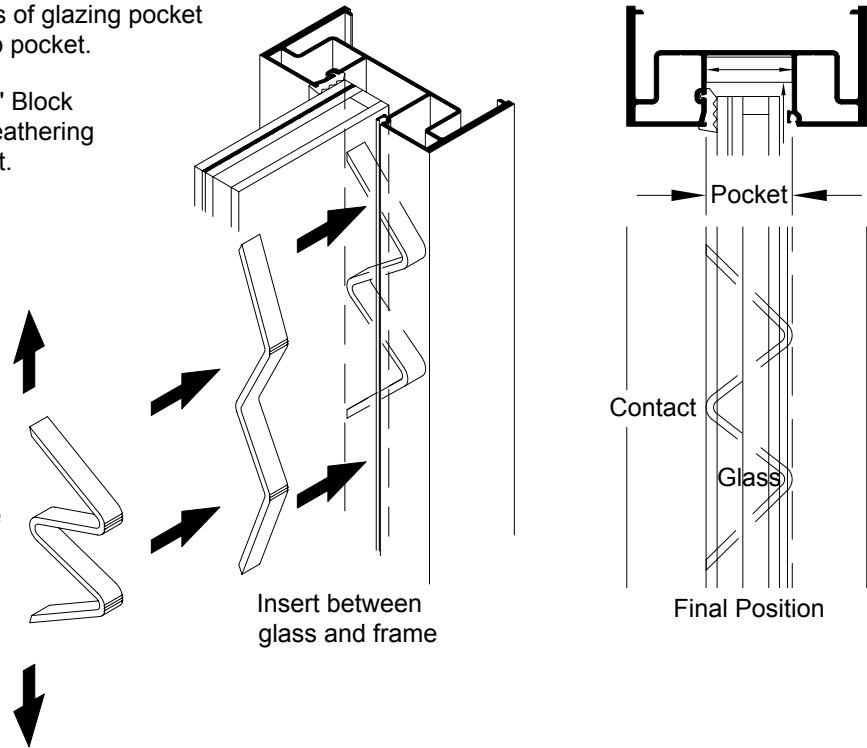

GASKET AND GLASS STOP INSTALLATION (Dry Glazing)

Step 1: Cut horizontal and vertical gaskets to an approximate length of D.L.O. + 1/4" per foot of D.L.O.

Step 2: Install gasket 127121 on the interior side of frame first. Insert gaskets into the horizontal members first starting at the ends and work toward the center as shown. (See Figure #1)

Step 3: Install vertical 127121 gaskets into the interior side of frame after horizontal gaskets are in place in the same manner. Vertical gasket runs through, trim edge of vertical gasket to pass by horizontal gasket.

Step 4: Apply sealant between vertical and horizontal gaskets.

Step 5: Position setting blocks at points under glass as required.

Step 6: Install glass into frame using standard flush glazing technique.

Step 7: Run bead of sealant along vertical reglets where glass stop meets, then install glass stop.

Step 8: Install exterior gasket into frame in the same manner as described in Step #2.

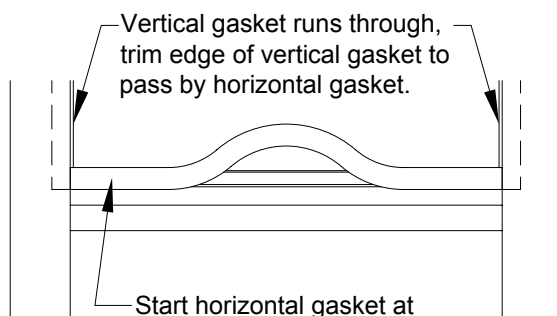
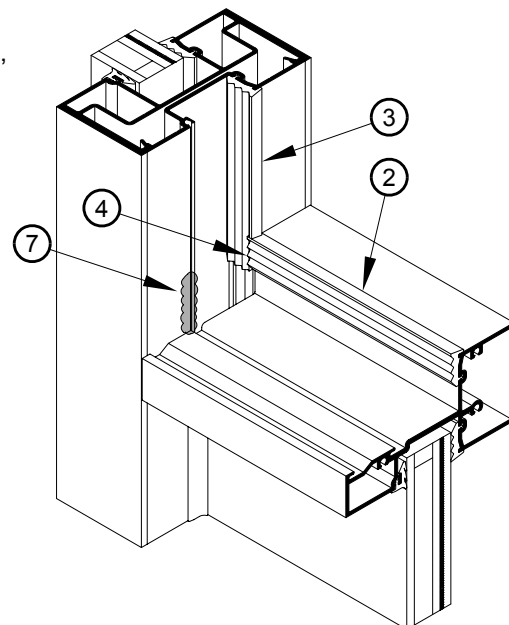

Figure #1

Start horizontal gasket at the ends and work towards the center of D.L.O.



Laws and building and safety codes governing the design and use of glazed entrance, window, and curtain wall products vary widely. Kawneer does not control the selection of product configurations, operating hardware, or glazing materials, and assumes no responsibility therefor.

Kawneer reserves the right to change configuration without prior notice when deemed necessary for product improvement.
© Kawneer Company, Inc. 2013

Laws and building and safety codes governing the design and use of glazed entrance, window, and curtain wall products vary widely. Kawneer does not control the selection of product configurations, operating hardware, or glazing materials, and assumes no responsibility therefor.

Run bead of sealant along vertical reglets where glass stop meets, then install glass stop

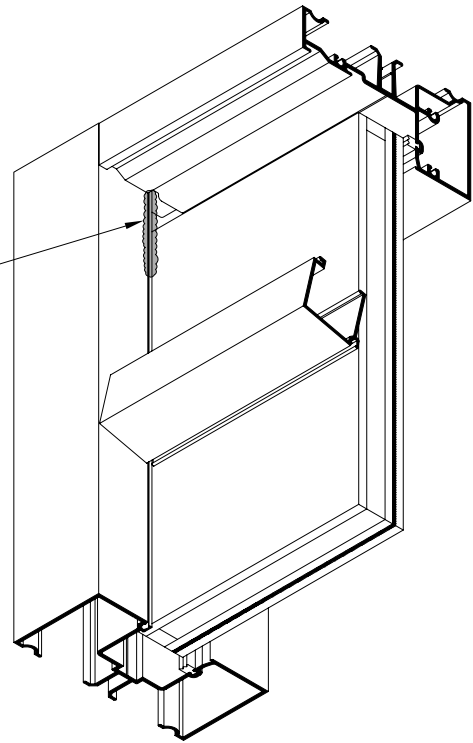

Install the glass stops by indexing them toward the glass to clear the hook legs on the horizontal members. Lower (raise at head) the stop to the horizontal member and pull out, making sure that both hook legs engage.

Cut the exterior push-in gasket to an approximate length of DLO + 1/4" per foot of DLO. Start the installation of the gaskets at the ends and work toward the center. The horizontal gaskets run through.

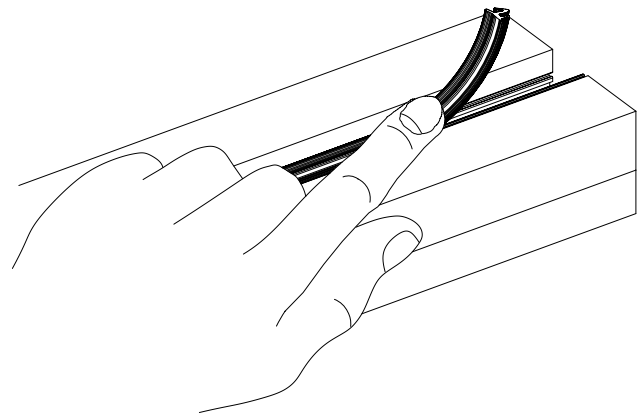
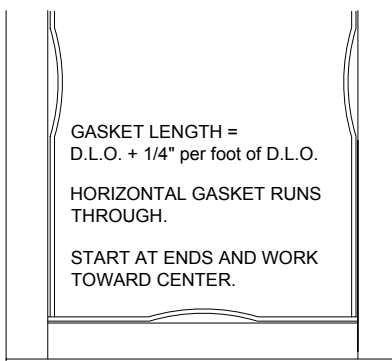

Kawneer reserves the right to change configuration without prior notice when deemed necessary for product improvement.

© Kawneer Company, Inc. 2013

Apply masking tape to the metal and glass.

Apply Dow Corning 995, 983 or Tremco Proglaze SSG silicone on the interior side of the glass pocket around all four sides of the glass. Make sure the silicone fills the entire cavity between the glass, frame and silicone spacer. Tool the silicone as necessary. Bevel the silicone at an approximate angle of 30 degrees so that you cannot see the exterior gasket from the inside. Remove the masking tape.

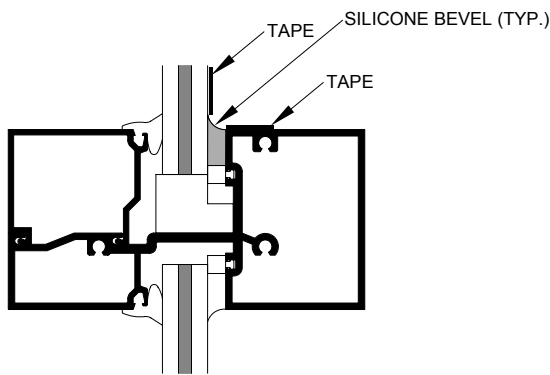
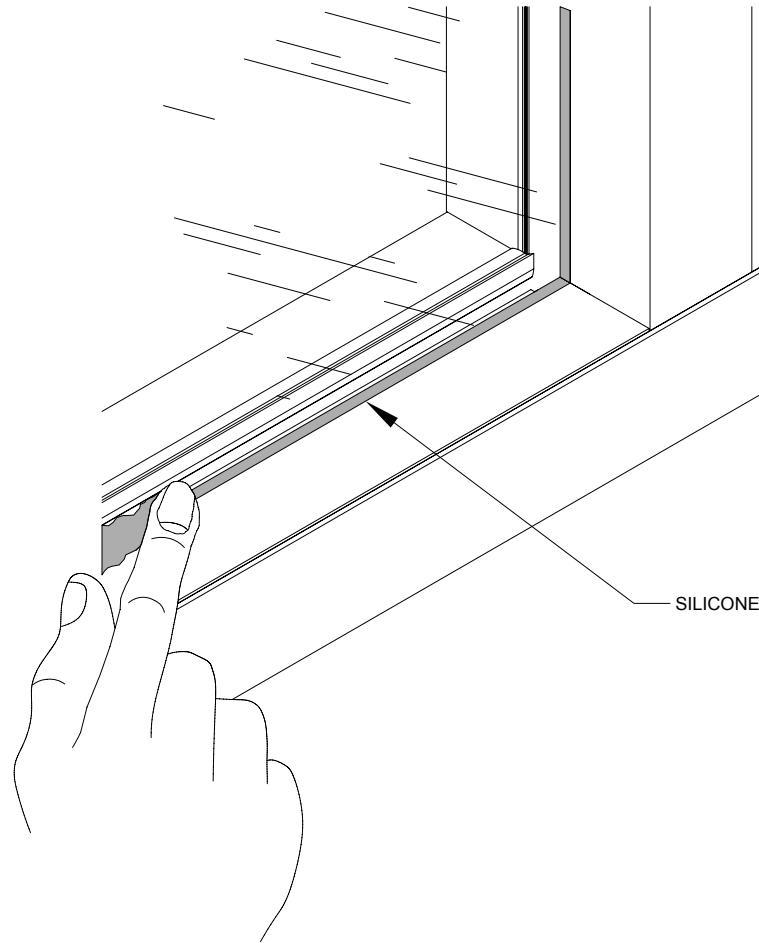

IR 500

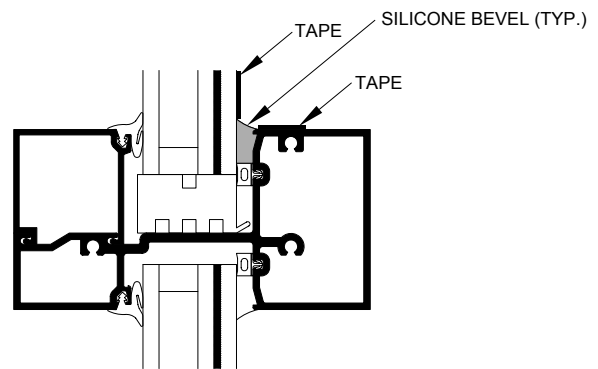

IR 501

Laws and building and safety codes governing the design and use of glazed entrance, window, and curtain wall products vary widely. Kawneer does not control the selection of product configurations, operating hardware, or glazing materials, and assumes no responsibility therefor.

Kawneer reserves the right to change configuration without prior notice when deemed necessary for product improvement.
© Kawneer Company, Inc. 2013

An expansion mullion should be used every 20' in large openings. The dimension of the assembly should be adjusted based on the temperature at the time of assembly and expected high and low service temperatures. Use 2-3/4" as a reference dimension. (For example, the sightline will be reduced slightly when installed in hot weather and increased slightly when installed in cold weather).

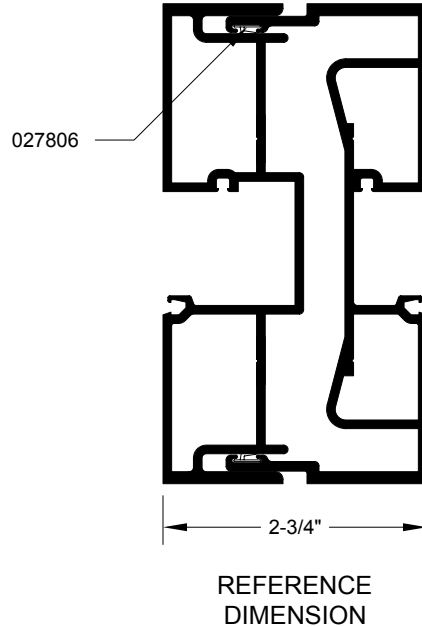

SECTION VII - STEEL REINFORCEMENT

575110 steel reinforcement should be used in the standard mullion and the expansion mullion as required by engineering calculations. 575111 steel reinforcement should be used in the door jambs. Steel reinforcement should run the full length of the mullion and be fastened into place as shown below. NOTE THAT THE STEEL MUST BE ATTACHED TO THE MULLIONS AFTER ASSEMBLY OF THE UNIT.

The cut ends of the steel reinforcement must be coated with a corrosion-inhibiting primer before installation.

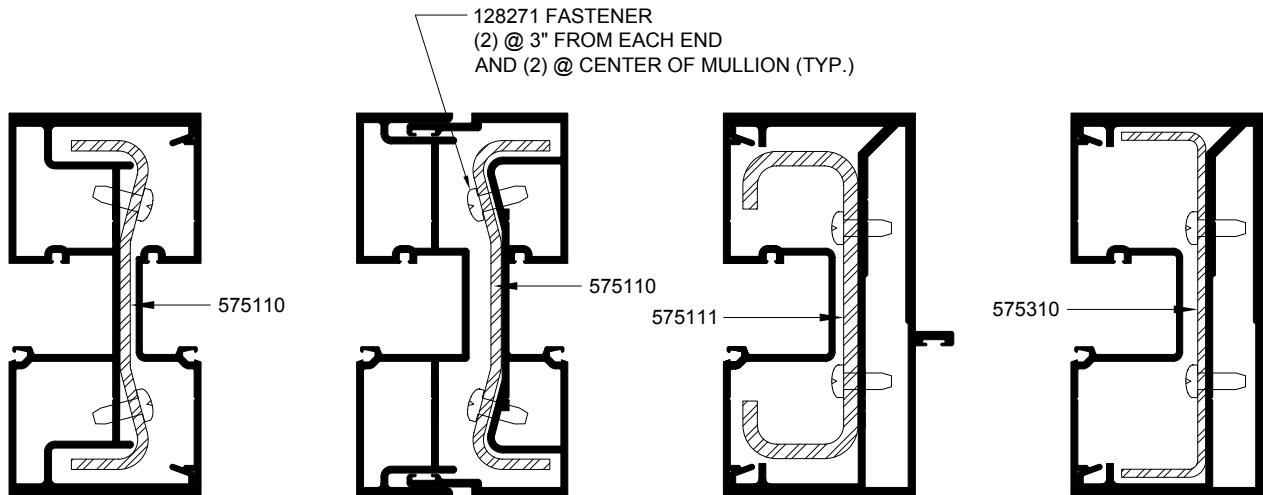

Laws and building and safety codes governing the design and use of glazed entrance, window, and curtain wall products vary widely. Kawneer does not control the selection of product configurations, operating hardware, or glazing materials, and assumes no responsibility therefor.

Kawneer reserves the right to change configuration without prior notice when deemed necessary for product improvement.

© Kawneer Company, Inc. 2013

Laws and building and safety codes governing the design and use of glazed entrance, window, and curtain wall products vary widely. Kawneer does not control the selection of product configurations, operating hardware, or glazing materials, and assumes no responsibility therefor.

Kawneer reserves the right to change configuration without prior notice when deemed necessary for product improvement.

© Kawneer Company, Inc. 2013

Laws and building and safety codes governing the design and use of glazed entrance, window, and curtain wall products vary widely. Kawneer does not control the selection of product configurations, operating hardware, or glazing materials, and assumes no responsibility therefor.

Kawneer reserves the right to change configuration without prior notice when deemed necessary for product improvement.

© Kawneer Company, Inc. 2013



KAWNEER COMPANY, INC.
TECHNOLOGY PARK/ATLANTA
555 GUTHRIDGE COURT
NORCROSS, GEORGIA 30092